

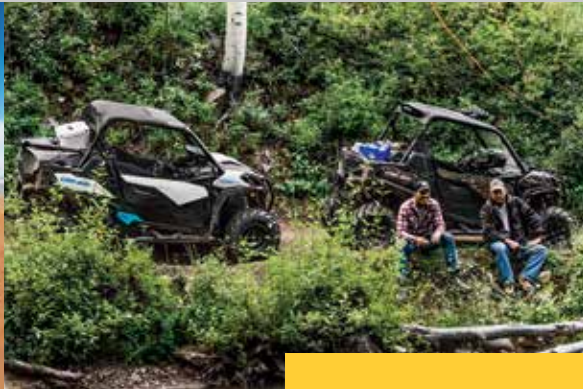

WE'RE  
BUILT  
FOR  
THIS



# *can-am*<sup>®</sup> MAVERICK TRAIL MAVERICK SPORT

ACCESSORIES,  
RIDING GEAR &  
GENUINE PARTS





# YOUR SEARCH FOR THE PERFECT ACCESSORIES STARTS & ENDS HERE

YOUR GUIDE TO ESSENTIAL FACTORY DEVELOPED AND APPROVED  
ACCESSORIES FOR YOUR CAN-AM.



## FIT & COMPATIBILITY

Innovative accessories that are simply better, together. Fit, function and looks—right out of the box—with the peace of mind that the accessories you pick will work perfectly with hundreds of others.



## QUALITY & RELIABILITY

Quality and reliability so good, it comes with a 1-year warranty. We stand strong behind our Genuine Can-Am accessories... because we can. Install them yourself or at an authorized dealer and immediately upgrade your off-road vehicle without worry.



## STYLE & VISION

Can-Am designers develop vehicles and accessories that look and perform right because they're for riders, period. Everything in this guide is here to benefit your experience—nothing else made the cut.

## BRP 1-YEAR LIMITED WARRANTY\*

For new Can-Am accessories, genuine parts, and co-branded products sold through BRP<sup>1</sup>. Includes items installed by you or an authorized BRP dealer.

**can-am**

<sup>1</sup>Use other than which the product is designed for will void the product lifetime warranty. <sup>2</sup>Applies only to BRP-made products or co-branded products made by accredited BRP partners (Lonestar Racing for Can-Am, DragonFire for Can-Am, S3 for Can-Am, Beard Seats for Can-Am, Baja Designs for Can-Am, etc.). Purchased at an authorized BRP dealership / distributor or on a BRP-authorized online store. Other exclusions may apply, see complete limited warranty or contact your Can-Am off-road authorized dealer. <sup>3</sup>Includes only BRP-approved aftermarket products and products made by currently accredited BRP partners. <sup>4</sup>Unless otherwise stipulated or required by law. This limited warranty does not apply to factory installed accessories. This limited warranty does not apply to Evinrude parts and accessories. This limited warranty is effective as of March 1<sup>st</sup>, 2016.



**can-am**  
MAVERICK TRAIL  
MAVERICK SPORT

2022

**TOP YOUR RIDE  
FOR ANYTHING**

Adapt to the conditions with  
the perfect bolt-on roof.  
P.9



**PROMOUNT  
— PLOWS**

**THE POWER TO PUSH FORWARD**

Designed to work as efficiently as possible, Can-Am  
reimagined the plow from frame to blade.

P.65



**APACHE**  
TRACK SYSTEMS

**TERRAIN IS NO LONGER THE LIMIT**

Get the most out of your Can-Am vehicle  
this winter for all your endeavors.

P.62

**4 ACCESSORIES**

4 Built Inspirations

9 Roofs

13 Soft Cabs

14 Windshields & Mirrors

18 Doors

21 Rear Wind Protection

22 Skid Plates

23 Bumpers & Guards

32 Seats

33 LinQ: Easy On Easy Off Cargo

38 Cargo & Storage

40 Racks & Holders

44 Lights

49 Audio & Communication

Systems

52 Electrical & Electronic

Accessories

56 Winches & Hitches

58 Performance

62 Apache™ Track Systems

65 Promount Plows

69 Trailering / Tires & Rims

**70 RIDING GEAR**

72 Can-Am Sportswear

73 Mud Gear

74 Helmets

75 Dust Masks /

Communication Systems

76 Goggles / Gloves / Junior

77 Bags / Sizing Chart

78 Branded Merchandise

**80 PARTS & MAINTENANCE**

80 Genuine Can-Am Parts

84 XPS Oils & Maintenance

**FULL AIRFLOW  
CONTROL**

From open to closed—and anywhere  
in between—at the touch of a button.

P.14



**NO MORE BUNGIES & ROPES**

P.33



Look for this logo throughout the catalogue for Expert  
recommendations on innovative, must-have, enthusiast-  
ready parts and accessories that will help you customize  
your perfect off-road machine.

**ENGINE OIL CHANGE KIT**

Want to save time and money? Use the ultra-convenient  
"all-in-one" DIY Engine Oil Change Kit

P.84





# PERFORMANCE

READY TO BUILD YOUR MAVERICK SPORT BEYOND FACTORY FRESH?



MAVERICK SPORT

Take your pick: Expertly-chosen STARTER, ADVANCE, and PEAK performance packages to take your Can-Am build to another level. Or simply mix and match and create your own package.

STARTER	715003831	Lonestar Racing Aluminum Roof	P.11	\$599.99
	715004871	Lonestar Racing Front Bumper	P.28	\$479.99
	715004873	Lonestar Racing Rear Bumper	P.28	\$519.99
	295100698	LinQ 4.2 Gal (16 L) Cooler	P.35	\$344.99
	<b>+</b>			<b>\$1,944.96</b>
ADVANCE	715004875	Lonestar Racing Rock Sliders	P.29	\$469.99
	715004872	Lonestar Racing Front Intrusion bar	P.29	\$499.99
	715005414	Lonestar Racing Rear Intrusion Bar	P.29	\$499.99
	710006028	Wet Sounds Stealth 6 Ultra HD Sound Bar	P.50	\$739.99
	715004007	39" (99 cm) Double Stacked LED Light Bar	P.45	\$869.99
	715004877	Lonestar Racing Mounts for LED Light Bar	P.48	\$309.99
	<b>+</b>			<b>\$5,334.90</b>
PEAK	715004876	Lonestar Racing Spare Tire Holder	P.29	\$309.99
	715004878	Lonestar Racing Number Plate	P.29	\$214.99
	715004459	Beard Suspension Seats	P.32	\$1,169.99
	715004234	4-Point Harness Drive	P.32	\$299.99
	715004235	4-Point Harness - Passenger	P.32	\$249.99
	715004452	Yoshimura Slip-On Exhaust	P.60	\$999.99
	715004902	S&B Particle Separator	P.61	\$519.99
				<b>\$9,099.83</b>

\*Note that price does not include installation requirements and that part numbers may vary depending on vehicle model.



**YOU CAN FINANCE THE PURCHASE OF ACCESSORIES**

with the purchase and financing of your Maverick Sport. Ask your dealer for all the details.

# ACTION

TRAIL-TUNED ACCESSORIES THAT SHARPEN YOUR RIDE TO PERFECTION.



MAVERICK SPORT

Take your pick: Expertly-chosen STARTER, ADVANCE, and PEAK action packages to take your Can-Am build to another level. Or simply mix and match and create your own package.

STARTER	715003659	Sport Roof	P.10	\$434.99
	715003656	Full Windshield - Hardcoated	P.16	\$689.99
	715005887	Soft Rear Window	P.21	\$149.99
	715003680	Front Trail Bumper	P.24	\$309.99
	715003683	Rear Trail Bumper	P.24	\$309.99
	715003701	All-Terrain Trunk Cover	P.38	\$599.99
	<b>+</b>			<b>\$2,494.94</b>
ADVANCE	715003639	Side Mirrors	P.17	\$234.99
	715003689	Rock Sliders	P.26	\$434.99
	715004912	Front Corner Protectors	P.25	\$149.99
	715004958	2" (51 mm) Fender Flares	P.26	\$274.99
	715003672	Complete Wet Sounds Audio System	P.50	\$939.99
	715002934	15" (38 cm) Double Stacked LED Light Bar	P.45	\$449.99
	<b>+</b>			<b>\$4,979.88</b>
PEAK	715003715	HMWPE Skid Plate Protection Kit	P.22	\$1,259.95
	715004471	Spare Tire Carrier	P.42	\$224.99
	715003692	Tail Light Protectors	P.26	\$99.99
	710006820	Baja Designs Squadron Sport LED Lights	P.44	\$299.99
715006110	Warn VRX 45 Winch	P.48	\$649.99	
				<b>\$7,514.79</b>

\*Note that price does not include installation requirements and that part numbers may vary depending on vehicle model.



**YOU CAN FINANCE THE PURCHASE OF ACCESSORIES**

with the purchase and financing of your Maverick Sport. Ask your dealer for all the details.



## WINTER

THRIVE IN THE DEEPEST SNOW—FOR WORK OR PLAY—WITH AN APACHE TRACK SYSTEM AND THE PROMOUNT PLOW. YOUR CAN-AM WAS BORN TO BE A WINTER WARRIOR.



MAVERICK TRAIL

Take your pick: Expertly-chosen STARTER and ADVANCE packages are the best way to quickly add cold-weather upgrades—plus plow and track kits for even more winter use. Or mix and match to create your perfect snow-ready Maverick Trail.

STARTER	715003618	Soft Cab Enclosure	P.13	\$2,099.99
	715003678	Defrost, Heat & Ventilation System	P.53	\$1,159.99
		<b>+</b>		<b>\$3,259.98</b>
ADVANCE	715003638	Panoramic Center Mirror	P.17	\$99.99
	715003771	LinQ Rack Extension	P.42	\$249.99
	710006028	Wet Sounds Stealth 6 Ultra HD Sound Bar	P.50	\$739.99
	715004500	Heated Grab Bar Cover	P.53	\$244.99
	715004283	Heated Steering Wheel	P.53	\$469.99
	715004501	Heated Seat Cover	P.53	\$249.99
	715003665	3.5" LED Flood Lights	P.46	\$249.99
	715003666	3.5" LED Driving Lights	P.46	\$249.99
				<b>\$5,814.90</b>
TRACKS	715005103	Apache 360 LT Tracks	P.64	\$4,924.99
	715004833	Apache 360 LT Track Mount Kit	P.64	\$604.99
				<b>\$11,344.88</b>
PLOW	715006417	Can-Am HD 4500-S Winch	P.56	\$519.99
	715005201	Can-Am Promount Steel 60" Plow Kit	P.66	\$849.97
	715004204	Can-Am Promount Frame Extension <i>*Required only if installed with Apache Tracks</i>	P.68	\$174.99
	715004206	Can-Am Promount Edge Markers	P.68	\$49.99
	715004207	Can-Am Promount Drift Cutters	P.68	\$149.99
				<b>\$13,089.81</b>

\*Note that price does not include installation requirements and that part numbers may vary depending on vehicle model.



### YOU CAN FINANCE THE PURCHASE OF ACCESSORIES

with the purchase and financing of your Maverick Trail. Ask your dealer for all the details.



## ADVENTURE

SHOW YOUR FRIENDS  
REAL ADVENTURE WITH  
ADRENALINE-INDUCING  
ADD-ONS FOR THE  
MAVERICK SPORT.



MAVERICK SPORT MAX

Take your pick: Expertly-chosen STARTER, ADVANCE, and PEAK adventure packages to take your Can-Am build to another level. Or simply mix and match and create your own package.

STARTER				
	715004704	Sport Roof (Max)	P.10	\$739.99
	715003658	PowerFlip Windshield	P.15	\$1,249.99
	715006113	Rear Polycarbonate Window	P.21	\$469.99
	715003680	Front Trail Bumper	P.24	\$309.99
	715003683	Rear Trail Bumper	P.24	\$309.99
	715004301	LinQ Tool Box	P.35	\$169.99
	295100698	LinQ 4.2 Gal (16 L) Cooler	P.35	\$344.99
	715004708	LinQ Pivoting Rack	P.41	\$559.99
	<b>+</b>			<b>\$4,154.92</b>
ADVANCE				
	715003639	Side Mirrors	P.17	\$234.99
	715004007	39" (99 cm) Double Stacked LED Light Bar	P.45	\$869.99
	715003668	Roof Tail Light	P.48	\$224.99
	715003672	Complete Wet Sounds Audio System	P.50	\$939.99
	715004095	Adventure Roof Rack	P.40	\$739.99
	<b>+</b>			<b>\$7,164.87</b>
PEAK				
	715006351	HMWPE Skid Plate Protection Kit	P.22	\$1,859.94
	715004794	Removable Center Storage Bag	P.39	\$149.99
	715004452	Yoshimura Slip-On Exhaust	P.60	\$999.99
				<b>\$10,174.79</b>

\*Note that price does not include installation requirements and that part numbers may vary depending on vehicle model.



### YOU CAN FINANCE THE PURCHASE OF ACCESSORIES

with the purchase and financing of your Maverick Sport MAX. Ask your dealer for all the details.

# CAN-AM ROOFS

Made with high-quality materials designed in concert with your Can-Am, our roofs create a strong, light, resilient barrier from the elements.



FIT &  
COMPATIBILITY



QUALITY &  
RELIABILITY



STYLE &  
VISION



BUILT FOR  
YOUR VEHICLE

Engineered with the same design, fit, finish, and built-to-last quality found across our lineup

**100%**  
integrated

into the design of all Can-Am cab components.



Make it  
**YOURS**

Roof options are the perfect platform for numerous Can-Am accessories that truly transform your Maverick Trail or Maverick Sport.







**BIMINI ROOF WITH SUN VISOR**

- Heavy-duty canvas made of UV-resistant solution-dyed polyester.
- Soft top comes with a hard visor that allows for storage of rolled-up soft top and mounting auxiliary lights.
- Compatible with all windshields, except the Glass Windshield with Wiper.

Maverick Trail, Maverick Sport	Maverick Sport MAX
715003661	715004792
\$369.99	\$459.99



**SPORT ROOF**

- Excellent protection from the elements.
- Allows to install lights at roof top location.
- Compatible with all windshields.

**Maverick Trail, Maverick Sport**

- Robust injection-molded polypropylene construction.

715003659
\$434.99

**Maverick Sport MAX**

- Robust thermoformed HMWPE construction.

715004704
\$739.99



More than a Sport Roof: It's a platform for seamlessly adding lights, windshields, sound systems, and intrusion protection.

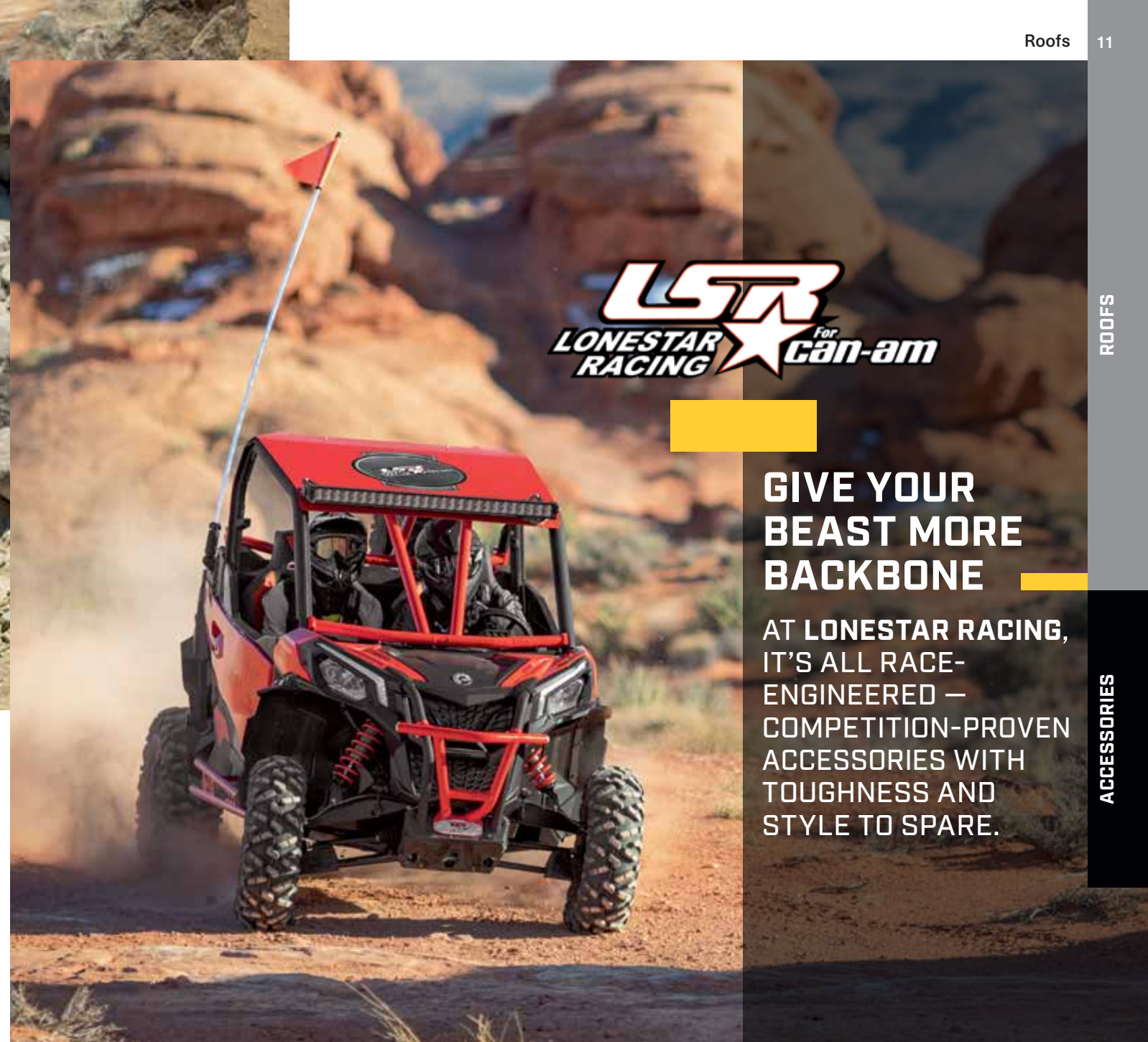

**GIVE YOUR BEAST MORE BACKBONE**

AT LONESTAR RACING, IT'S ALL RACE-ENGINEERED — COMPETITION-PROVEN ACCESSORIES WITH TOUGHNESS AND STYLE TO SPARE.

**LONESTAR RACING ALUMINUM ROOF**

- Race-true low profile look with integrated front visor for eye-popping performance and protection.
- 0.083" (2.1 mm) thick aluminum roof for durable and lightweight protection from the elements.
- Compatible with Lonestar Racing Mounts for 39" (99 cm) Double Stacked LED Light Bar.
- Not compatible with Full Windshields, Rigid Rear Window, Can-Am Intrusion Bars and Overhead Switch Panel.

**Maverick Trail, Maverick Sport**

- 715005137 • Black
- 715003831 • Can-Am Red

**\$599.99**

**Maverick Sport MAX**

- 715004892 • Can-Am Red

**\$999.99**







## TRAIL-PROVEN STRENGTH

LOOKS & STRENGTH GO TOGETHER WITH DRAGONFIRE ACCESSORIES PACKING UNMISTAKABLE STYLE AND OUTSTANDING PROTECTION.

### DRAGONFIRE ALUMINUM ROOF

- Durable and lightweight formed aluminum roof with durable powder coat finish.
- Sleek lines designed to match your vehicle's body and greatly enhance the overall look.
- Compatible with all windshields.

**Maverick Trail, Maverick Sport**  
715004458  
\$599.99

**Maverick Sport MAX**  
715004891  
\$1,199.99



# WRAP YOURSELF IN COMFORT



### SOFT CAB ENCLOSURE

- Outstanding Soft Cab Enclosure gives protection and comfort against all the elements.

#### Maverick Trail

- Includes:**
- Sport Roof
  - Full Windshield - Hardcoated
  - Upper Soft Door Panels
  - Soft Rear Panel
  - Door Seal Kit
  - Requires Half Doors on 800 Base and 800 DPS models
  - Not compatible with Sport Half Doors

715003618  
\$2,099.99

#### Maverick Trail / Maverick Sport

- Can be installed on the Maverick Trail equipped with the Sport Half Doors or on Maverick Sport models.

- Includes:**
- Sport Roof
  - Full Windshield - Hardcoated
  - Upper Soft Door Panels
  - Soft Rear Panel

715004724  
\$2,099.99

#### Maverick Sport MAX

- Includes:**
- Sport Roof
  - Full Windshield - Hardcoated
  - Upper Soft Door Panels
  - Soft Rear Panel

715004725  
\$3,259.95



MAVERICK TRAIL



MAVERICK SPORT MAX

## DESIGN YOUR OWN CAB.

PICK THE ACCESSORIES OF YOUR CHOICE AND BUILD OR COMPLETE YOUR OWN CAB.

✓ 100% modular components designed to work together:

**ROOFS** P.9  
**WINDSHIELDS** P.14

**DOORS** P.18  
**REAR WINDOWS** P.21



# CAN-AM WINDSHIELDS

Developed together with your Maverick Sport and Maverick Trail to ensure they fit, look and perform as they should.



**FIT & COMPATIBILITY**



**QUALITY & RELIABILITY**



**STYLE & VISION**



## OVER CENTER LATCHES

Quick and easy tool-less installation or removal as the conditions and your needs change.



### Quantum+ Coating

Our Full Windshield - Hardcoated is made of high-impact-resistant Quantum+ hardcoated polycarbonate to ensure a long life.

## 100% integrated

Your Can-Am's standard profiled cage allows our accessories to install easily, with a perfect fit.

## POWERFLIP WINDSHIELD

Allows you to quickly adapt to changing conditions by adjusting the windshield as you go.

# WINDSHIELDS & MIRRORS



## TOTAL AIR FLOW CONTROL

Industry's first POWERED FLIP WINDSHIELD



**FULLY OPENED**  
for optimal visibility and ventilation



**INFINITE POSSIBILITIES IN BETWEEN**  
depending on protection, visibility and air flow preferences



**FULLY CLOSED**  
for maximum protection from the elements

### POWERFLIP WINDSHIELD

- The PowerFlip Windshield is equipped with electric pistons that allow the rider to adjust the windshield opening at the touch of a button.
- Windshield is made of hardcoated polycarbonate with a rubber seal contour and a tinted top section.
- Allows you to quickly adapt to changing conditions by adjusting the windshield as you go.
- Can be fully opened for optimal visibility and ventilation, fully closed for maximum protection from the elements, and in between, you have an infinite number of opening possibilities depending on protection, visibility and air flow preferences.
- Compatible with Can-Am roofs.

**Maverick Trail, Maverick Sport, Maverick Sport MAX**  
715003658  
**\$1,249.99**



**EXPERT CHOICE**

Powerful electric pistons allow the PowerFlip windshield to open and adjust quickly as you go—at the touch of a button.





**GLASS WINDSHIELD**

- Curved and laminated glass full windshield in metal frame.
- Provides excellent optical clarity.
- Seals firmly against the cage and protects rider and passenger from the elements.
- Must be used with Windshield Wiper and Washer Kit (715003654) to maintain clear visibility during severe riding conditions, such as mud riding.
- Must be used with rear wind protection.
- Not EC compliant.

**Maverick Trail, Maverick Sport, Maverick Sport MAX**  
715003653  
**\$1,169.99**



**GLASS WINDSHIELD WITH WIPER**

- (Not illustrated)
- Curved and laminated glass full windshield in metal frame.
  - Provides excellent optical clarity.
  - Seals firmly against the cage and protects rider and passenger from the elements.
  - Single-speed wiper with washer fluid dispenser.
  - Requires the Overhead Switch Panel (715003669) for installation.
  - Must be used with rear wind protection.
  - Not EC compliant.

**Maverick Trail, Maverick Sport, Maverick Sport MAX**  
715003652  
**\$1,799.99**

**WINDSHIELD WIPER & WASHER KIT**

- An ideal way to keep your windshield clear in rain, or while riding through mud and water.
- Includes single-speed wiper, washer fluid dispenser and windshield frame mount.
- Must be used with the Glass Windshield (715003653).
- Requires the Overhead Switch Panel (715003669) for installation.
- Not EC compliant.

**Maverick Trail, Maverick Sport, Maverick Sport MAX**  
715003654  
**\$669.99**



**FULL WINDSHIELD - HARDCOATED**

- High-impact-resistant Quantum<sup>1</sup> hardcoated polycarbonate full windshield.
- Formed polycarbonate construction for enhanced rigidity.
- Provides excellent optical clarity and better abrasion resistance.
- Seals firmly against the cage and protects rider and passenger from the elements.
- Must be used with rear wind protection.
- Quick and easy tool-less installation or removal.

**Maverick Trail, Maverick Sport, Maverick Sport MAX**  
715003656  
**\$689.99**

**EXPERT CHOICE**

The Quantum<sup>1</sup> coating provides excellent optical clarity and better abrasion resistance.



**FULL WINDSHIELD**

- High-impact-resistant durable polycarbonate full windshield.
- Formed polycarbonate construction for enhanced rigidity.
- Seals firmly against the cage and protects rider and passenger from the elements.
- Formulated to be non-yellowing, non-crazing, non-cracking with excellent UV resistance and optical clarity.
- Must be used with rear wind protection.
- Quick and easy tool-less installation or removal.

**Maverick Trail, Maverick Sport, Maverick Sport MAX**  
715003655  
**\$459.99**



**New SIDE WINDSHIELD DEFLECTORS**

- Clear polycarbonate air deflectors mount on each side of the cage.
- Not compatible with Full Doors.
- Sold in pairs.
- Compatible with all windshields.

**Maverick Sport, Maverick Sport MAX, Maverick Trail**  
715004310  
**\$209.99**

- Can be adjusted at three different positions for cabin air flow control when a full windshield is installed:
  - 1) Outside deflection to reduce cabin air flow and turbulence.
  - 2) Inside deflection to increase air flow in the cabin.
  - 3) Windshield ventilation to reduce fog.



**EXPERT CHOICE**

Easily redirect air flow around the cab for better comfort and dust deflection.



**HALF WINDSHIELD**

- Formed polycarbonate construction for enhanced rigidity.
- Formulated to be non-yellowing, non-crazing, non-cracking with excellent UV resistance and optical clarity.
- Protects driver and passenger from the elements.
- Features reverse angle lip to deflect air flow.
- Quick and easy tool-less installation or removal.

**Maverick Trail, Maverick Sport, Maverick Sport MAX**

**CLEAR**

715003657  
**\$279.99**



**TINTED**

715005280  
**\$309.99**



**SIDE MIRRORS**

- Rugged black nylon 6/6 construction with coated cast-aluminum mount.
- Dual adjustment (horizontal and vertical) will suit any rider.
- Convex optics deliver optimal field of view (FOV).
- Spring-loaded pivots let mirrors fold back completely.
- Sold in pairs.

**Maverick Trail, Maverick Sport, Maverick Sport MAX**  
715003639  
**\$234.99**



**PANORAMIC CENTER MIRROR**

- Wide-angle convex mirror.
- Offers enhanced visibility.
- Can be used with or without roof or windshield.

**Maverick Trail, Maverick Sport, Maverick Sport MAX**  
715003638  
**\$99.99**



**SPORT PANORAMIC CENTER MIRROR**

- Convex mirror for wide rearward visibility.
- Ball-joint design with tightening knob for steady multi-angle adjustment.
- Can be used with or without roof or windshield.
- Not for road use.

**Maverick Trail, Maverick Sport, Maverick Sport MAX**  
715004924  
**\$99.99**





# CAN-AM DOORS

Developed together with your Maverick Sport and Maverick Trail. Comfort, protection and great looks built to outlast any trail.



**FIT & COMPATIBILITY**



**QUALITY & RELIABILITY**



**STYLE & VISION**

**100%**

**integrated**

All our doors seamlessly integrate with your vehicle.



## UPPER SOFT DOOR PANELS

Quickly open up or enclose the cockpit with zippered windows made from robust laminated, polished vinyl.



## Best protection from the elements

Can-Am doors seal with a frame that sits firmly against the cage.



## Tool-lessly removable

Once installed, our doors are easy to remove on hot and sunny days.



## TRAIL HALF DOORS

- Half doors made of molded polypropylene to match vehicle's styling.
- Steel frame for high level of rigidity.
- A must-have for additional cabin comfort.
- Keep the vehicle narrow in tight trail riding conditions.
- Door Trim is required to complete your door kit (sold separately).
- Standard on 1000 Base and 1000 DPS models.
- Sold in pairs.

**Maverick Trail**  
715004418  
\$679.99



## DOOR TRIM

- Matching colored panel for Trail Half Doors.
- Required to complete the Trail Half Doors (sold separately).
- Sold in pairs.

**Maverick Trail**  
 715004802 • White  
 715005083 • Sunburst Yellow  
**\$184.99**  
 715006104 • Can-Am Red **New**  
**\$324.99**

## SPORT HALF DOORS

- Half doors made of molded polypropylene to match vehicle's styling.
- A must-have for additional cabin comfort.
- Features rounded shape to increase cabin space.
- Standard on all Maverick Sport models.
- Can be installed on Maverick Trail models for additional cabin space.
- Door Trim is required to complete your door kit (sold separately).
- Sold in pairs.

**Maverick Trail, Maverick Sport, Maverick Sport MAX**  
715006217  
\$979.99



## **New** DOOR TRIM

- Matching colored panel for the Sport Half Doors.
- Required to complete the Sport Half Doors (sold separately).
- Sold in pairs.

**Maverick Trail, Maverick Sport, Maverick Sport MAX**  
 715006216 • Carbon Black  
 715006105 • Can-Am Red  
**\$499.99**



**UPPER SOFT DOOR PANELS**

- Upper canvas portion of the doors with sturdy steel frame.
- Seal firmly against the cage and protect rider and passenger from the elements.
- Convert half door into full door for a complete cab enclosure.
- Zippered window made of laminated polished vinyl material for added ventilation.
- Easy to remove on hot and sunny days.
- Must be used with the Sport Roof for maximum sealing.

**Maverick Trail, Maverick Sport**

- Can be installed on the Maverick Trail equipped with the Sport Half Doors or with the standard half doors on Maverick Sport models.
- Not compatible with Trail Half Doors or with the standard half doors on Maverick Trail models.

715004718

**\$839.99**

**Maverick Sport MAX**

- Include Upper Soft Door Panels for front and rear doors.

715004727

**\$1,679.98**

**Maverick Trail**

- Can only be installed with Trail Half Doors or with the standard half doors on Maverick Trail models.
- Not compatible with Sport Half Doors or with the standard half doors on Maverick Sport models.

715003620

**\$839.99**



Seals firmly against the cage, protecting rider and passenger from the elements.

**DOOR SEAL KIT**

- (Not illustrated)
- Improves door sealing from the elements and provides additional cabin comfort.
  - Included in the Soft Cab Enclosure Kit (715003618).
  - Not compatible with Sport Half Doors.
  - Compatible with the Trail Half Doors or with the stock doors on the Maverick Trail.

**Maverick Trail**

715004773

**\$34.99**

**DOOR KNEE PADS WITH STORAGE**

- Padded door cushion with integrated pocket for storage.
- Protect driver and passenger legs from direct contact with the doors while riding.
- Increase cabin comfort.
- Require Trail Half Door on 800 Base and 800 DPS models.
- Offer storage space for small items.
- Sold in pairs.
- Not compatible with Sport Half Doors.

**Maverick Trail**

715003635

**\$159.99**



**DOOR STORAGE WITH PADDING**

- Weather-resistant door storage bags with integrated padding.
- Holds your gear safely and securely and also protects driver and passenger legs from direct contact with the doors while riding.
- Each bag is designed as a 0.5 Gal (2 L) capacity pocket also equipped with inner netting compartments.
- Semi-rigid construction renders them flexible enough to fit odd-shaped loads.
- Easy to install.
- Sold in pairs.
- Bags attach on stock doors of the Maverick Sport or on the Maverick Trail equipped with the Sport Half Doors.
- Not compatible with stock doors on the Maverick Trail or the Trail Half Doors.

**Maverick Trail, Maverick Sport, Maverick Sport MAX**

715004914

**\$174.99**



STAY CLEANER AND WARMER WHILE RIDING THROUGH THE WORST



**REAR POLYCARBONATE WINDOW**

- High-impact-resistant polycarbonate window.
- Blocks windshield backdraft or dust and rain from entering for added cabin comfort.
- Sport Roof (715003659 or 715004704 for MAX) is required for installation.
- Not compatible with Bimini Roof with Sun Visor, Dragonfire Aluminum Roof and Lonestar Racing Aluminum Roof.

**Maverick Trail, Maverick Sport, Maverick Sport MAX**

715006113

**\$469.99**



**SOFT REAR PANEL**

- Plastic reinforced and weather-resistant rear panel offers good protection from the elements.
- Made of heavy-duty UV-resistant solution-dyed polyester canvas for excellent resistance to tear and abrasion.
- Clear window made of laminated polished vinyl material.
- Resists cold cracking.
- Installs quick and easily on roll cage.

**Maverick Trail, Maverick Sport, Maverick Sport MAX**

715005887

**\$149.99**



**REAR WIND SCREEN**

- Full rear mesh screen reduces windshield backdraft for added cabin comfort.
- Installs quick and easily on roll cage.
- Large Can-Am branding.

**Maverick Trail, Maverick Sport, Maverick Sport MAX**

715003664

**\$109.99**





EXPERT CHOICE

# HMWPE SKID PLATES

Our Plastic Plates glide smoothly and silently over obstacles, offering great protection in rough terrain. Made of abrasion-resistant thermoformed 3/8" (10 mm) thick High Molecular Weight Polyethylene (HMWPE).

- ✓ Lighter than aluminum
- ✓ Superior stress crack resistance
- ✓ High impact strength



Offer your Maverick Sport or Maverick Trail the full protection kit, or get the individual parts you need.	Maverick Sport & Maverick Sport Max					Maverick Trail
	2019		2020		ANY YEAR	
	Base & DPS	X mr	Base & DPS	X mr & X xc	X rc	
<b>HMWPE SKID PLATE PROTECTION KIT</b>	<b>New</b> 715006348 (except Max) <b>\$1,444.95</b>	<b>New</b> 715006353 <b>\$1,534.95</b>	<b>New</b> 715006349 (except Max) <b>\$1,444.95</b>	<b>New</b> 715006350 <b>\$1,543.95</b>	—	<b>New</b> 715006346 (2019 & prior) <b>\$1,359.95</b>
	<b>New</b> 715006352 (Max only) <b>\$1,859.94</b>		<b>New</b> 715006351 (Max only) <b>\$1,859.94</b>			<b>New</b> 715006347 (2020) <b>\$1,359.95</b>
<b>HMWPE SKID PLATES</b>						
① <b>HMWPE FRONT SKID PLATE</b>	715004260 <b>\$134.99</b>	715004260 <b>\$134.99</b>	715004260 <b>\$134.99</b>	715004260 <b>\$134.99</b>	(Standard on X rc models)	715004260 <b>\$134.99</b>
② <b>HMWPE FRONT A-ARM PROTECTORS</b>	715004270 <b>\$199.99</b>	<b>New</b> 715006340 <b>\$239.99</b>	715004270 <b>\$199.99</b>	<b>New</b> 715006340 <b>\$239.99</b>	(Standard on X rc models)	715003698 <b>\$149.99</b>
③ <b>HMWPE UNDERBELLY PLATES</b> • Keep the rollover clearance.	<b>New</b> 715006339 <b>\$599.99</b>	<b>New</b> 715006339 <b>\$599.99</b>	<b>New</b> 715006273 <b>\$599.99</b>	<b>New</b> 715006273 <b>\$599.99</b>	<b>New</b> 715006339 (2019) <b>\$599.99</b> <b>New</b> 715006273 (2020) <b>\$599.99</b>	<b>New</b> 715006339 (2019 & prior) <b>\$599.99</b> <b>New</b> 715006273 (2020) <b>\$599.99</b>
④ <b>HMWPE REAR SKID PLATE</b>	715004261 <b>\$299.99</b>	715004261 <b>\$299.99</b>	715004261 <b>\$299.99</b>	715004261 <b>\$299.99</b>	715004261 <b>\$299.99</b>	715004261 <b>\$299.99</b>
⑤ <b>HMWPE REAR A-ARM PROTECTORS</b>	715004271 <b>\$209.99</b>	<b>New</b> 715006341 <b>\$259.99</b>	715004271 <b>\$209.99</b>	<b>New</b> 715006341 <b>\$259.99</b>	(Standard on X rc models)	715003699 <b>\$174.99</b>
⑥ <b>HMWPE CENTRAL SKID PLATE</b>	715004272 (Max only) <b>\$414.99</b>	—	715004272 (Max only) <b>\$414.99</b>	—	—	—

# CAN-AM BUMPERS

The strength to endure and the character to wear well—our bumpers are ready for it.

  
**FIT & COMPATIBILITY**

  
**QUALITY & RELIABILITY**

  
**STYLE & VISION**

  
**BETTER CORROSION PROTECTION**

Can-Am bumpers are E-Coated for excellent corrosion protection inside and out.

**FIT & COMPATIBILITY**

**QUALITY & RELIABILITY**

**STYLE & VISION**



  
**LIGHT ready**  
Fully Integrated light mounting plate.  
Multiple light installation option.



**100% integrated**  
Designed to seamlessly integrate with the style, fit, finish, and capability of your Maverick Sport and Maverick Trail.





**FRONT CORNER PROTECTORS**

- Heavy-duty 1.5" (3.8 cm) diameter steel tubing.
- Inside and outside anti-corrosion coating with durable powder coat finish.
- Provide additional protection for vehicle's front corners.
- Require Front Trail Bumper (715003680/715003681) for installation (not compatible with the Front Rancher Bumper).
- Sold in pairs.

**Maverick Trail, Maverick Sport, Maverick Sport MAX**

- 715004912 • Black
- 715005230 • Sunburst Yellow

**\$149.99**



**FRONT INTRUSION BAR**

- Steel intrusion bar matches perfectly with vehicle's styling.
- Inside and outside anti-corrosion coating with durable powder coat finish.
- Provides additional protection by preventing large objects from entering the driver/passenger area.
- Tube design reduces obstructed lines of sight and blind spots for better visibility.
- Not compatible with windshields and Upper Soft Door Panels.

**Maverick Trail, Maverick Sport, Maverick Sport MAX**

715003872

**\$369.99**



**FRONT TRAIL BUMPER**

- Front bumper made of heavy-duty 1.5" (3.8 cm) diameter steel tubing.
- Completes the stock bumper for more front coverage and essential vehicle protection for trail riders.
- Inside and outside anti-corrosion coating with durable powder coat finish.
- Includes integrated mount points for light installation.

**Maverick Trail, Maverick Sport, Maverick Sport MAX**

- 715003680 • Black
- 715003681 • Sunburst Yellow

**\$309.99**



**REAR TRAIL BUMPER**

- Rear bumper made of heavy-duty 1.5" (3.8 cm) diameter steel tubing.
- Protects vehicle bodywork and exhaust system.
- Inside and outside anti-corrosion coating with durable powder coat finish.

**Maverick Trail, Maverick Sport, Maverick Sport MAX**

- 715003683 • Black
- 715003684 • Sunburst Yellow

**\$309.99**



Inside and outside anti-corrosion coating with durable powder coat finish.

**RANCHER FRONT BUMPER**

- Heavy-duty protection made of 1.5" (3.8 cm) diameter steel tubing, perfect for farm, ranch and forestry applications.
- Inside and outside anti-corrosion coating with durable powder coat finish.
- Offers full front coverage and superior headlight protection.
- Removable radiator protector to allow light installation.
- Rugged look.
- Not EC compliant.

**Maverick Trail, Maverick Sport, Maverick Sport MAX**

715004303

**\$529.99**



**RANCHER REAR BUMPER**

- Heavy-duty protection made of 1.5" (3.8 cm) diameter steel tubing, perfect for farm, ranch and forestry applications.
- Inside and outside anti-corrosion coating with durable powder coat finish.
- Offers full rear coverage with integrated tail light protectors.
- Not EC compliant.

**Maverick Trail, Maverick Sport, Maverick Sport MAX**

715004304

**\$399.99**







**ROCK SLIDERS**

- Made of heavy-duty 1.5" (3.8 cm) diameter steel tubing.
- Inside and outside anti-corrosion coating with durable powder coat finish.
- Protect vehicle's rocker panels and undercarriage against large obstacles.
- Sold in pairs.

**Maverick Trail, Maverick Sport (except X rc)**

- 715003689 • Black
- 715005228 • Sunburst Yellow

**\$434.99**

**Maverick Sport MAX**

- 715004754 • Black

**\$559.99**



**TAIL LIGHT PROTECTORS**

- Anti-corrosion coating with durable powder coat finish.
- Rugged style, aggressive look.
- Sold in pairs.
- Not EC compliant.

**Maverick Trail, Maverick Sport, Maverick Sport MAX**

715003692

**\$99.99**



**2" (51 MM) FENDER FLARES**

- Extended fender flares made from injection-molded polypropylene.
- Keep mud and debris out of vehicle.
- Designed for quick and easy installation.
- Include front and rear extensions, mounting hardware and Fender Flare Rear Extensions (715004404).
- Increase vehicle's overall width by 3.5" (8.9 cm).

**Maverick Trail**

715004958

**\$274.99**



**FENDER FLARE REAR EXTENSIONS**

- Help tail light stay clean from debris and mud to remain visible. Can be installed with 2" (51 mm) Fender Flares (715003625) or with the standard fender flares on Maverick Sport models to keep mud and debris out of cargo area.
- Made from injection-molded polypropylene for best fit and finish.
- Sold in pairs.
- Included with the 2" (51 mm) Fender Flares (715004958) and with the Fender Flare Extensions (715004462).

**Maverick Trail, Maverick Sport, Maverick Sport MAX**

715004404

**\$49.99**

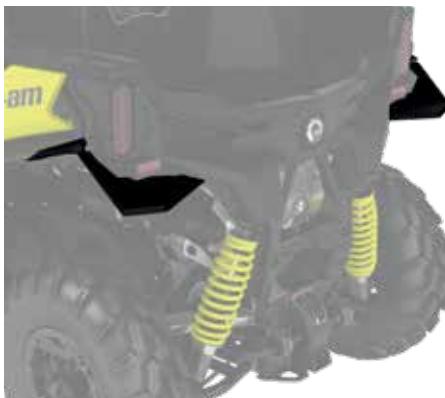

**3" (76 MM) FENDER FLARES**

- Fender flares made from injection-molded polypropylene.
- Keep mud and debris out of vehicle.
- Designed for quick and easy installation.
- Include front and rear extensions and mounting hardware.
- Increase vehicle's overall width by 6" (15.3 cm) when installed on Maverick Trail models.
- Standard on Maverick Sport models.

**Maverick Trail, Maverick Sport, Maverick Sport Max**

715004959

**\$249.99**



**FENDER FLARE EXTENSIONS**

- Block terrain debris from kicking up onto you as you ride or damaging your vehicle thanks to these extra-large Fender Flare Extensions, which also include rear extensions (715004404) for added protection from mud/snow, especially when riding with track kits.
- Made from injection-molded polypropylene for best fit and finish.
- Not compatible with 2" (51 mm) Fender Flares.
- Include front and rear extensions.
- For Maverick Trail, must be used with 3" (76 mm) Fender Flares (715004959).
- Standard on Maverick Sport X mr models.

**Maverick Trail, Maverick Sport, Maverick Sport MAX**

715004462

**\$274.99**



**RADIATOR PROTECTOR**

- Perforated steel shield mounted over the radiator face, providing protection from stones and branches.
- Not recommended for winter use.

**Maverick Trail, Maverick Sport, Maverick Sport MAX**

715003700

**\$99.99**

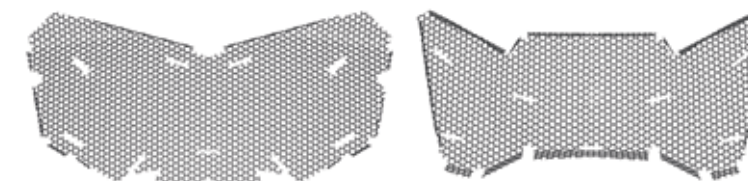





LONESTAR RACING FRONT INTRUSION BAR P.29

LONESTAR RACING ROCK SLIDERS P.29

LONESTAR RACING FRONT BUMPER



**PEAK PERFORMANCE NEVER LOOKED SO HOT**

Race-engineered with a reputation for toughness and style, Lonestar Racing accessories play just as hard as you want to.

**LONESTAR RACING FRONT BUMPER**

- Race-engineered to Lonestar Racing's trademark standards for toughness, these stylishly crafted accessories will also enhance your vehicle with visual impact.
- Made of 1.5" (3.8 cm) diameter steel tubing with durable powder coat finish.
- Billet End Cap with Lonestar Racing logo.
- Compatible with synthetic rope winches and Hawse Fairlead.

Maverick Trail, Maverick Sport, Maverick Sport MAX

- 715005131 • Black
- 715004871 • Can-Am Red

**\$479.99**



**LONESTAR RACING REAR BUMPER**

- Race-engineered to Lonestar Racing's trademark standards for toughness, these stylishly crafted accessories will also enhance your vehicle with visual impact.
- Made of 1.5" (3.8 cm) diameter steel tubing with durable powder coat finish.
- Billet End Cap with Lonestar Racing logo.
- Provides additional vehicle-rear bodywork and exhaust system protection in extreme driving conditions.

Maverick Trail, Maverick Sport, Maverick Sport MAX

- 715005133 • Black
- 715004873 • Can-Am Red

**\$519.99**



**LONESTAR RACING FRONT INTRUSION BAR**

- Race-engineered to Lonestar Racing's trademark standards for toughness, these stylishly crafted accessories will also enhance your vehicle with visual impact.
- Made of 1.5" (3.8 cm) diameter steel tubing with durable powder coat finish.
- Provides additional protection for driver and passenger.
- Compatible with Lonestar Racing Aluminum Roof.
- Not compatible with windshields, Bimini Roof with Sun Visor and Sport Roof.

Maverick Trail, Maverick Sport, Maverick Sport MAX

- 715005132 • Black
- 715004872 • Can-Am Red

**\$499.99**



**LONESTAR RACING REAR INTRUSION BAR**

- Race-engineered to Lonestar Racing's trademark standards for toughness, these stylishly crafted accessories will also enhance your vehicle with visual impact.
- Made of 1.5" (3.8 cm) diameter steel tubing with durable powder coat finish.

- Provides additional protection for driver and passenger.
- Not compatible with the Sport Roof, rear panels and windows, All-Terrain Trunk Cover.

Maverick Trail, Maverick Sport

Not compatible with S&B Particle Separator

- 715005134 • Black
- 715004874 • Can-Am Red

**\$499.99**

Maverick Trail, Maverick Sport

Compatible with S & B Particle Separator

- (Not illustrated)
- 715005413 • Black
- 715005414 • Can-Am Red\*

**\$499.99**

Maverick Sport MAX

Compatible with S&B Particle Separator

- 715005420 • Black
- 715005421 • Can-Am Red

**\$499.99**



715004874



715005420

**LONESTAR RACING ROCK SLIDERS**

- Race-engineered to Lonestar Racing's trademark standards for toughness, these stylishly crafted accessories will also enhance your vehicle with visual impact.
- Made of 1.5" (3.8 cm) diameter steel tubing with durable powder coat finish filled with 1/8" (3 mm) aluminum plate.
- Billet End Cap with Lonestar Racing logo.
- Protect vehicle sides from large obstacles.
- Sold in pairs.

Maverick Trail, Maverick Sport (except X re)

- 715005135 • Black
- 715004875 • Can-Am Red

**\$469.99**

Maverick Sport MAX

- 715004893 • Can-Am Red

**\$899.99**



715005135



715004893

**LONESTAR RACING SPARE TIRE HOLDER**

- Race-conceived for riders who believe a Plan B means thinking like a pro.
- Holds wheel securely no matter how rough the trail.
- Made of 1.5" (3.8 cm) diameter steel tubing with durable powder coat finish.
- Easy, bolt-on installation on roll cage.
- Can accommodate tires up to 27".
- Wheel not included.
- Not compatible with All-Terrain Trunk Cover, Fixed Tailgate, LinQ Cargo Rack and LinQ Rack Extension.
- Not compatible with LinQ Pivoting Rack.

Maverick Trail, Maverick Sport, Maverick Sport MAX

- 715005136 • Black
- 715004876 • Can-Am Red

**\$309.99**



**LONESTAR RACING NUMBER PLATE**

- Race-bred in the Lonestar tradition of competition-level riding, this number plate will brand your vehicle a winner.
- Includes a pair of sturdy aluminum number plates.
- Create your personalized number decal through SCS Unlimited.
- Not compatible with the All-Terrain Trunk Cover.

Maverick Trail, Maverick Sport, Maverick Sport MAX

715004878

**\$214.99**







**TRAIL-TOUGH STRENGTH**

Sharp lines and the toughness to endure—DragonFire accessories match your Can-Am and enhance its potential.

DRAGONFIRE FRONT BUMPER

DRAGONFIRE ROCK SLIDERS P.31



DRAGONFIRE SPARE TIRE HOLDER

DRAGONFIRE REAR BUMPER P.30

**DRAGONFIRE FRONT BUMPER**

- 1.5" (3.8 cm) diameter steel tubing with durable powder coat finish and reinforced with a 0,09" (2.3 mm) thick steel plate.
- Delivers additional protection for your vehicle.
- Sleek lines designed to match your vehicle's body and greatly enhance the overall look.
- Combines perfectly with the DragonFire Front Exo-Frame.
- Billet End Caps with DragonFire Logo.
- Not compatible with the Front Receiver Hitch.
- Includes brackets for auxiliary light mounting.

**Maverick Trail, Maverick Sport, Maverick Sport MAX**

- 715004456 • Can-Am Red
- 715005128 • Black

**\$479.99**

**DRAGONFIRE REAR BUMPER**

- 1.5" (3.8 cm) diameter steel tubing with durable powder coat finish and reinforced with a 0,09" (2.3 mm) thick steel plate.
- Delivers additional protection for your vehicle.
- Sleek lines designed to match your vehicle's body and greatly enhance the overall look.
- Billet End Caps with DragonFire Logo.

**Maverick Trail, Maverick Sport, Maverick Sport MAX**

- 715004457 • Can-Am Red
- 715005129 • Black

**\$479.99**

**DRAGONFIRE SPARE TIRE HOLDER**

- 1.5" (3.8 cm) diameter steel tubing with durable powder coat finish.
- Sleek lines designed to match your vehicle's body and greatly enhance the overall look.
- Easy-to-install roll cage mounted spare-tire holder.
- Accommodates tires up to 28" in diameter (wheel not included).
- Uses standard bolt pattern for wheel installation.
- Not compatible with LinQ Pivoting Rack (715004708), All-Terrain Trunk Cover, Gear Rail and LinQ accessories mounted in the cargo bed.

**Maverick Trail, Maverick Sport, Maverick Sport MAX**

- 715004443 • Can-Am Red
- 715005125 • Black

**\$324.99**

**DRAGONFIRE FRONT INTRUSION BAR**

- 1.25" (3.2 cm) diameter steel tubing with durable powder coat finish.
- Provides additional protection for driver and passenger.
- Unique design with a centered upper portion to minimize effects on visibility.
- Sleek lines designed to match your vehicle's body and greatly enhance the overall look.
- Compatible with all polycarbonate windshields.
- Not compatible with Bimini and Sport Roofs and Glass Windshields.

**Maverick Trail, Maverick Sport, Maverick Sport MAX**

- 715004455 • Can-Am Red
- 715005126 • Black

**\$469.99**



**DRAGONFIRE FRONT EXO-FRAME**

- 1.5" (3.8 cm) diameter steel tubing with durable powder coat finish.
- Provides full front-corner and side-body protection.
- Sleek lines designed to match your vehicle's body and greatly enhance the overall look.
- DragonFire Front Bumper (715004456/715005128) is required for installation.
- Sold in pairs.

**Maverick Trail, Maverick Sport, Maverick Sport MAX**

- 715004801 • Can-Am Red
- 715005127 • Black

**\$324.99**



**DRAGONFIRE ROCK SLIDERS**

- 1.25" (3.2 cm) diameter steel tubing with durable powder coat finish.
- Sleek lines designed to match your vehicle's body and greatly enhance the overall look.
- Protect vehicle's undercarriage with minimal effect on ground clearance.
- 0,09" (2.3 mm) steel plate wraps the lower side of the vehicle for additional lateral protection.
- Sold in pairs.

**Maverick Trail, Maverick Sport (except X rc)**

- 715003690 • Can-Am Red
- 715005130 • Black

**\$519.99**

**Maverick Sport MAX**

- 715005160 • Black

**\$699.99**







DESIGNED FOR COMFORT AND STABILITY, THESE RACE-INSPIRED, 4-POINT HARNESS-READY SEATS SECURE RIDERS FOR INCREASED BALANCE, FOCUS, AND COMFORT OVER CHALLENGING TERRAIN.

**BEARD SUSPENSION SEATS**

- True suspension seating for driver and passenger seats.
- Designed specifically for side-by-side vehicle applications.
- Offer great posture for both driver and passenger during intense riding conditions.
- Feature a high and unmatched level of containment support, which gives superior comfort and stability.
- Made of rigid welded-steel frame, covered with sculpted foam and wrapped with a custom cover of premium marine-grade vinyl, which is durable in all driving conditions and resistant to mildew and fading.
- Enhance the racing look of the vehicle.
- No additional seat mounts required.
- Sold in pairs.

**Maverick Trail, Maverick Sport, Maverick Sport MAX (Back seats only on MAX model)**  
 ■ 715004459 • Black  
 ■ 715004460 • Can-Am Red  
**\$1,169.99**

**Maverick Sport MAX (Front seats)**  
 ■ 715004894 • Black  
 ■ 715004895 • Can-Am Red  
**\$1,169.99**



**4-POINT HARNESS**

- Exclusive controlled decelerator technology (patent pending) absorbs additional energy in case of an accident.
- Designed to offer maximum riding comfort.
- Easy one-click latch and release.
- Not EC compliant.
- ROHVA compliant.
- 4-Point Harness Bar is required for front seat on Max models.

**Maverick Trail, Maverick Sport, Maverick Sport MAX**  
 715004234 • Driver  
**\$299.99**  
 715004235 • Passenger  
**\$249.99**



**4-POINT HARNESS BAR**

- Allows you to install 4-point harnesses on the front passenger and driver seats of a Maverick Sport Max.
- 4-point harnesses need to be installed for both driver and front passenger seats when the 4-Point Harness Bar is installed.

**Maverick Sport MAX**  
 715004847  
**\$309.99**



**SEAT BELT SHOULDER PADS**

- Provide additional riding comfort by preventing seat belt from rubbing on neck and shoulder.
- Fit with standard 3-point seat belts.
- Easy Velcro installation.
- Can-Am branded.
- Sold in pairs for driver and passenger.

**Maverick Trail, Maverick Sport, Maverick Sport MAX**  
 715002894  
**\$49.99**



EASY ON EASY OFF CARGO

A BRP exclusive, LinQ is a tool-less system for near-instant installation of accessories. Quickly, easily install and remove LinQ accessories to transform your machine for the moment.



FIT & COMPATIBILITY



QUALITY & RELIABILITY



STYLE & VISION



**TOOL-LESS**

Twist LinQ fasteners and go!



**YOUR ADVENTURE, OUTFITTED**

LinQ trunk boxes, rack extensions, bags, baskets, and gear grips attach quickly for your next expedition.

**LinQ ACCESSORY TYPES**

- **LinQ** with 16" base accessories are mounted with LinQ anchors 16 inches apart, ideal for Can-Am ATVs and SSVs, Sea-Doo watercraft, and Ski-Doo snowmobiles.
- **LinQ** with 36" base accessories are most commonly used as part of LinQ racks for Can-Am Off-Road vehicles.

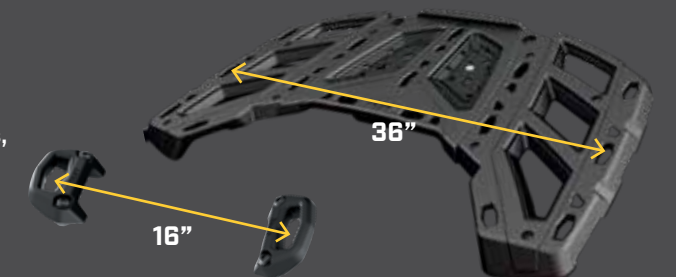



# LinQ SYSTEM™ ACCESSORIES

- No tools needed: Quickly install and remove accessories by hand
- Equip your Can-Am for specialized tasks in no time
- Sturdy mounting system that holds up to the roughest terrain

## Mounting location and requirements

Vehicle Standard Cargo Box	Passenger Seat Base	LinQ Cargo Rack 715003702	LinQ Pivoting Rack 715004708	Adventure Roof Rack 715004095

### LinQ ACCESSORIES WITH 16" BASE P. 35

- LinQ anchors mounted 16 inches apart, center-to-center.
- Lower loading capacity than the LinQ with 36" base accessories.
- Can be used on Can-Am ATV and SSV vehicles, Sea-Doo watercrafts and Ski-Doo snowmobiles.

<b>LinQ 4.2 GAL (16 L) COOLER</b> 295100698	LinQ Anchor Kit 860201806 + LinQ Anchor Installation Kit 715004461	Not compatible	LinQ Anchor Adapter Kit 715004960	LinQ Anchor Kit 860201806
<b>LinQ TOOL BOX</b> 715004301				
<b>LinQ SR 5.5 GAL (21 L) BAG</b> 860201740	LinQ Anchor Installation Kit 715004461	Passenger Seat LinQ Anchor Kit 715003951	No further requirements	No further requirements
<b>LinQ 4.5 GAL (17 L) SPORT BAG</b> 860201678				
<b>New LinQ DRY BAG</b> 715002875				

### LinQ ACCESSORIES WITH 36" BASE P. 36-37

- Mount on LinQ racks often used by Can-Am ORV vehicles.
- Higher loading capacity than the LinQ with 16" base accessories.
- Usage is limited to Can-Am ORV vehicles.

<b>LinQ 12 GAL (45L) CARGO BOX</b> 715003879	Not compatible	Not compatible	No further requirements	No further requirements	Not compatible
<b>LinQ 23 GAL (86L) TRUNK BOX</b> 715004923					
<b>LinQ 32 GAL (124L) TRUNK BOX</b> 715001747					
<b>LinQ 11.5 GAL (43L) AUDIO CARGO BOX</b> 715003018					
<b>LinQ 8 GAL (30L) COOLER BOX</b> 715004778 • Black / 715004698 • Grey	Not compatible	Not compatible	No further requirements	No further requirements	Not compatible
<b>LinQ PREMIUM STORAGE BAG BY OGIO</b> 715002923 • Black / 715003248 • Camo					
<b>LinQ HEAVY DUTY BASKET</b> 715001215					
<b>LinQ LOW PROFILE BASKET</b> 715004282					

### LinQ RACKS & HOLDERS P. 42

<b>LinQ TOOL HOLDER</b> 715003059	No further requirements (when installed on side walls)	No further requirements	Not compatible	No further requirements	Side wall installation: <b>LinQ Adapters</b> 715003058
--------------------------------------	--	-------------------------	----------------	-------------------------	--

# LinQ: EASY ON EASY OFF CARGO



## LinQ ACCESSORIES WITH 16" BASE

### LinQ 4.2 GAL (16 L) COOLER

- Rotomolded construction for exceptional rigidity and durability.
- Premium-quality foam insulation for optimal ice retention.
- Marinized for salt water purposes.
- See table for installation location and requirements.

**Maverick Trail, Maverick Sport, Maverick Sport MAX**  
295100698  
**\$344.99**



**EXPERT CHOICE**

One of the most versatile and popular coolers on the market made for rugged use.

### LinQ TOOL BOX

- High precision injected HDPE construction provides rigidity and durability.
- 5 Gal (19 L) maximum capacity.
- Weather-resistant, sealed and lockable cover.
- LinQ Cargo Base Kit (860201806) included.
- Marinized for salt water purposes.
- See table for installation location and requirements.

**Maverick Trail, Maverick Sport, Maverick Sport MAX**  
715004301  
**\$169.99**



### LinQ SR 5.5 GAL (21 L) BAG

- Semi-rigid expandable bag.
- 5.5 Gal (21L) capacity.
- LinQ Cargo Base Kit (860201806) included.
- See table for installation location and requirements.

**Maverick Trail, Maverick Sport, Maverick Sport MAX**  
860201740  
**\$219.99**



### New LinQ 4.5 GAL (17 L) SPORT BAG

- 4.5 Gal (17 L) capacity.
- Rigid bottom, semi-rigid top.
- See table for installation location and requirements.

**Maverick Trail, Maverick Sport, Maverick Sport MAX**  
860201678  
**\$204.99**



### New LinQ DRY BAG

- Fully waterproof roll-top dry bag will securely store and confine your equipment.
- LinQ mounted using heavy-duty rigid plastic base.
- High capacity storage solution (40 L).
- Bottom foam liner for additional equipment protection.
- Integrated handle for easy transportation on/off vehicle.
- LinQ Cargo Base Kit (860201806) included.
- Marinized for salt water purposes.
- See table for installation location and requirements.

**Maverick Trail, Maverick Sport, Maverick Sport MAX**  
715002875  
**\$219.99**



### LinQ PASSENGER SEAT BASE KIT

- LinQ base kit that installs on the passenger seat frame underneath the bottom seat cushion.
- Allows installation of compatible LinQ accessories inside the cabin.
- Passenger seat cushion can be reinstalled over the LinQ base kit when not in use.

**Maverick Trail, Maverick Sport, Maverick Sport MAX**  
715003951  
**\$59.99**



### LinQ CARGO BASE KIT

- Allows installation of compatible LinQ accessories.
- Included: 2 LinQ Cargo bases and hardware.

**Maverick Trail, Maverick Sport, Maverick Sport MAX**  
860201806  
**\$29.99**

### LinQ BASE INSTALLATION KIT

- (Not illustrated)
  - Required to install LinQ Cargo Base Kit in cargo box.
- Maverick Trail, Maverick Sport, Maverick Sport MAX**  
715004461  
**\$24.99**

### LinQ REPLACEMENT PART

- Sold in pairs.
- Maverick Trail, Maverick Sport, Maverick Sport MAX**  
715001707  
**\$25.99**



### New LinQ ANCHOR ADAPTER KIT

- Allows the installation of LinQ accessories with 16" base on LinQ racks.
- Tool-less installation and removal.
- LinQ Pivoting Rack (715004708) is required for installation.

**Maverick Trail, Maverick Sport, Maverick Sport MAX**  
715004960  
**\$74.99**







LinQ ACCESSORIES WITH 36" BASE

**LinQ 12 GAL (45L) CARGO BOX**

- LinQ mounted for easy on, easy off installation.
- Holds cargo safely and securely while riding.
- See table for installation location and requirements.

**Maverick Trail, Maverick Sport, Maverick Sport MAX**

715003879

**\$274.99**



**LinQ 23 GAL (86L) TRUNK BOX**

- LinQ mounted for easy on, easy off installation.
- Lockable and weather-resistant.
- Holds cargo safely and securely while riding.
- See table for installation location and requirements.

**Maverick Trail, Maverick Sport, Maverick Sport MAX**

715004923

**\$334.99**



**LinQ 32 GAL (124L) TRUNK BOX**

- Equipped with the LinQ System, the rear trunk box plugs in and out in seconds.
- 32 Gal (124L) load capacity with unobstructed space to maximize storage room and access to the trunk's interior.
- Made of injection-molded polyethylene, double walled in critical areas.
- The fully sealed lid protects your belongings from dust, moisture and the elements.
- Trunk Box Panels available in many colors to match your vehicle (sold separately).
- See table for installation location and requirements.

**Maverick Trail, Maverick Sport, Maverick Sport MAX**

715001747 • Black (Rear tail light included)

**European Version (EC compliant)**

715001748 (No rear tail light)

**\$369.99**



**LinQ 32 GAL (124L) TRUNK BOX PANELS**

- Color panels to match the LinQ 32 Gal (124L) to your vehicle.

**Maverick Trail, Maverick Sport, Maverick Sport MAX**

715001391 • Black

715001392 • Yellow

715001395 • Viper Red

715002481 • White

715002480 • Light Grey

715002984 • Octane Blue

715002985 • Manta Green

715002986 • Can-Am Red

715006119 • Orange Crush **New**

715006120 • Squadron Green **New**

**\$59.99**

**European Version (EC compliant)**

• No rear tail light

715001397 • Black

715001398 • Yellow

715002482 • Light Grey

715002483 • White

715006121 • Can-Am Red

715006122 • Manta Green

715006123 • Orange Crush

715006124 • Viper Red

**LinQ PREMIUM STORAGE BAG BY DGIO**

- Tool-less installation and removal thanks to the LinQ System.
- 17.2 Gal (65 L) capacity semi-rigid cargo bag ideal for carrying anything you need on your vehicle.
- Buckle and elastic closure with a rubber seal that protects dust from entering the bag.
- 3-section lid for partial or full access to your bag.
- Inside separators for optimal bag organization.
- LinQ Cargo Rack (715003702) or LinQ Pivoting Rack (715004708) is required for installation.
- See table for installation location and requirements.

**Maverick Trail, Maverick Sport, Maverick Sport MAX**

715002923 • Black

**\$469.99**

715003248 • Mossy Oak Break-Up Country Camo

**\$549.99**



Inside separators for optimal bag organization

**LinQ 11.5 GAL (43L) AUDIO CARGO BOX**

- An affordable and quick solution for adding music and storage to your next ride.
- The rear installation does not use up any cab space and allows easy listening at an average speed.
- Mounts on/off easily to hold/carry cargo safely and securely.
- Backlit control panel perfect for night riding.
- Water-resistant speakers.
- The Bluetooth enabled receiver and 6.5" (16.5 cm) speakers are smartly concealed and integrated in the cover.
- Automatic shut-off function protects your battery by turning the system off after 10 minutes of inactivity.
- See table for installation location and requirements.

**Maverick Trail, Maverick Sport, Maverick Sport MAX**

715003018

**\$659.99**



**LinQ 8 GAL (30L) COOLER BOX**

- Installs without vehicle modification.
- LinQ mounted for easy on, easy off installation.
- Rotomolded construction provides exceptional rigidity and durability.
- Premium-quality foam insulation for optimal ice retention.
- Integrated, fully-removable compartment protects food.
- Robust rubber latches keep the cover tightly closed.
- Weather-resistant.
- Convenient drain plug.
- See table for installation location and requirements.

**Maverick Trail, Maverick Sport, Maverick Sport MAX**

715004698 • Grey

715004778 • Black

**\$429.99**



**LinQ HEAVY-DUTY BASKET**

- Made of high-strength, low-alloy steel.
- LinQ mount for easy on, easy off installation.
- See table for installation location and requirements.

**Maverick Trail, Maverick Sport, Maverick Sport MAX**

715001215

**\$254.99**



**LinQ LOW PROFILE BASKET**

- Low profile, open basket increases cargo space.
- Perfect for easy access to tools, rope, winch and plow accessories.
- Multiple bungee cord and tie-down anchor points.
- Made of impact-resistant injected polypropylene.
- See table for installation location and requirements.

**Maverick Trail, Maverick Sport, Maverick Sport MAX**

715004282

**\$194.99**





GIVE YOUR CAN-AM THE CARGO CAPACITY TO CARRY THE LOAD— ANYWHERE



ALL-TERRAIN TRUNK COVER



### ALL-TERRAIN TRUNK COVER

- Transforms your rear cargo area into a fully enclosed and weather-resistant car-like trunk box.
- Gas spring assisted opening.
- Integrated mounting location inside the trunk cover for Dome Light (715002455) (sold separately).
- Rotomolded construction provides exceptional rigidity.
- LinQ accessories can be installed on or inside the trunk cover.
- LinQ Cargo Base Kit (860201806) required for installation on the trunk cover.

**Maverick Trail, Maverick Sport, Maverick Sport MAX**

715003701

**\$599.99**



**EXPERT CHOICE**

Transforms your vehicle, creating a fully-enclosed and weather-resistant cargo area.

### FIXED TAILGATE

- Rigid rotomolded construction.
- Encloses perfectly the rear cargo opening and helps cargo securely in place.
- Matches the vehicle's styling.

**Maverick Trail, Maverick Sport, Maverick Sport MAX**

715004357

**\$199.99**



### SOFT COOLER

- Soft cooler made of durable canvas.
- Removable shoulder strap and carry handles.
- Foam insulation and water-resistant interior liner.
- 2.2 Gal (4.5 L) capacity.

**Maverick Trail, Maverick Sport, Maverick Sport MAX**

715003728

**\$36.99**



### SOFT STORAGE BAG

(Not illustrated)

- 11.8 Gal (45L) capacity soft cargo bag designed with vehicle's rear in mind to maximize potential storage.
- 3 sections.
- Weatherproof.

**Maverick Trail, Maverick Sport, Maverick Sport MAX**

715003759 • Black

**\$174.99**

### OVERHEAD STORAGE BAGS

- Weather-resistant bags, hold your gear safely and securely while riding.
- Include 2 overhead soft bags mounted on a tubular frame that sits between cage and roof.
- 2.4 Gal (9L) total capacity.
- Bimini Roof with Sun Visor or Sport Roof needed for installation.

**Maverick Trail, Maverick Sport, Maverick Sport MAX**

715005018

**\$149.99**



### SHOULDER STORAGE BAG

- Weather-resistant semi-rigid bag, holds your gear safely and securely while riding.
- Bag attaches in unused space between the seats to increase your vehicle's cargo capacity.
- 2.8 Gal (10.5L) capacity.
- Not compatible with Beard Seats.

**Maverick Trail, Maverick Sport, Maverick Sport MAX**

715005019

**\$124.99**



### REMOVABLE CENTRAL STORAGE BAG

- Weather-resistant bag, holds your gear safely and securely while riding.
- Both front and rear passengers can access the bag's content.
- Designed as a 1.3 Gal (5.2L) capacity pocket, also equipped with inner netting compartments and side pockets.
- Can be removed in seconds and includes shoulder strap for transportation.
- Perfect to bring your gear on and off your vehicle.

**Maverick Sport MAX**

715004794

**\$149.99**



### STORAGE 2.6 GAL (10L) BAG

- Roll-top dry bag for fully protecting your cargo from the elements.

**Maverick Trail, Maverick Sport, Maverick Sport MAX**

269502121

**\$35.99**







## BUILT FOR ADVENTURE

Pack everything you need to live your off-road experience.

### New ADVENTURE ROOF RACK

- Ideal cargo solution for packing everything you need to live your off-road experience fully and completely.
- Built with heavy-duty 1.5" (3.8 cm) and 1.25" (3.2 cm) diameter steel tubing.
- Loads of up to 75 lb (34 kg).
- LinQ support plates allow for installation of LinQ accessories with 16" base.
- Integrated mounting points for the installation of the 39" (99 cm) Double Stacked LED Light Bar (front).
- Features anchor points for spare tire attachment.
- Spare Tire Tie-Downs sold separately.
- Add the Cargo Box Net to secure and confine your cargo in the rack.
- Can be installed without a roof or with Sport Roof.

#### Maverick Sport MAX

715004095

\$739.99



### SPARE TIRE RATCHET TIE-DOWNS

- 3-way ratcheting tie-down strap with loop ends.
- Designed to securely hold spare tires on accessories equipped with integrated spare tire attachment points.
- Adjustable to accommodate most common UTV tire sizes.
- Ratchet and junction ring made of durable zinc-plated steel.
- Required for spare tire attachment on Adventure Roof Rack.

28000606

\$30.99



### CARGO BOX NET

- Solid net designed to secure and assure a compact confinement of your Adventure Roof Rack cargo.

715001371

\$74.99



## RACKS & HOLDERS

### LinQ PIVOTING RACK

- LinQ latched rack allows for extra LinQ mounted accessories or for carrying a spare tire (tire not included).
- Includes custom tie-down strap for fast spare tire installation or removal.
- Gas-cylinder pivot action, locks in the raised position.
- Not compatible with Gear Rail, Lonestar Racing and DragonFire tire carrier, Lonestar Racing Number Plate, rear intrusion bars and LinQ Cargo Rack.
- Compatible with the All-Terrain Trunk Cover.

#### Maverick Trail, Maverick Sport,

Maverick Sport MAX

715004708

\$559.99



EXPERT  
CHOICE

Carry a spare tire and cargo. The pivoting rack adds function where it counts.

### FRONT RACK

- Rugged looking front rack mounts on top of vehicle hood and provides additional protection and cargo capacity.
- Heavy-duty 3/4" (1.9 cm) diameter steel-tube construction.
- 50 lb (22.7 kg) load capacity.
- Inside and outside anti-corrosion coating
- with durable powder coat finish.
- Flip-up configuration provides easy access to service area.
- Can be installed with or without a front bumper.
- Not compatible with DragonFire Front Exo-Frame.

#### Maverick Trail, Maverick Sport, Maverick Sport MAX

715004302

\$309.99







**LinQ SYSTEM™** RACKS & HOLDERS

**LinQ CARGO RACK**

- Made of durable die cast aluminium and strong aluminium tubing frame.
- Allows the installation of LinQ Trunk Boxes on top, and the addition of more LinQ accessories in cargo box.
- Easy and tool-less installation thanks to the LinQ System.

Maverick Trail, Maverick Sport, Maverick Sport MAX

715003702

**\$399.99**



**LinQ RACK EXTENSION**

- Made of strong and durable die cast aluminium.
- Helps to keep cargo securely in place.
- Easy and tool-less installation thanks to the LinQ System.

Maverick Trail, Maverick Sport, Maverick Sport MAX

715003771

**\$249.99**



Keep cargo where it belongs with raised trunk side bars.

**LinQ TOOL HOLDER**

- Ultra-versatile tool holder.
- Convenient swivel-latch allows tools to be stored in any orientation.
- Sold in pairs.
- Not compatible inside the cargo box.

Maverick Trail, Maverick Sport, Maverick Sport MAX

715003059

**\$64.99**



**STRONGHOLD GUN BOOT IMPACT<sup>†</sup> BY KOLPIN<sup>†</sup>**

- Compact low-profile design with Kolpin Stronghold styling securely holds up to 52" (132 cm) long rifles and shotguns with optics.
- Includes a removable, shock absorbing foam Impact<sup>†</sup> liner.
- Single-handed opening with an attached lid for quick access along with an integrated closure strap.
- For use with the Kolpin Stronghold Auto-Latch Mount System.

Maverick Trail, Maverick Sport, Maverick Sport MAX

705011442

**\$114.99**



**STRONGHOLD AUTO-LATCH MOUNT BY KOLPIN**

- Auto-latching design provides quick and secure gun boot attachment to your vehicle.
- Bracket is made from rugged high-impact, reinforced nylon and coated steel.
- For use with Stronghold Gun Boot (705011442).
- Requires Gear Rail (715003703).

Maverick Trail, Maverick Sport, Maverick Sport MAX

715003899

**\$79.99**



**SPARE TIRE CARRIER**

- Holds spare tire in place.
- Designed for fast tire removal.
- Can hold tires up to 30" in diameter (tire is not included).
- Rear bumper mounted, does not encumber the cargo area.
- Made of heavy-duty 1.5" (3.8 cm) diameter steel tubing.
- Inside and outside anti-corrosion coating with durable powder coat finish.
- The Wheel Jack (715001719) can be attached by using the Spare Tire Ratchet Tie-Downs (280000606).
- Requires Rear Trail Bumper (715003683) or Rear Rancher Bumper (715004304).

Maverick Trail, Maverick Sport, Maverick Sport MAX

715004471

**\$224.99**



**UNIVERSAL SAW PRESS BY KOLPIN**

- Specially crafted for transporting your chainsaw securely and safely aboard your side-by-side vehicle.
- Heavy-duty, black powder-coated metal bracket designed to attach any chainsaw model with up to a 20" (51 cm) bar.
- Rubber pads provide cushion and tight fit.
- Hinged design for quick removal.
- Holds saw in vertical position or 45° angle in either direction.
- Requires Gear Rail (715003703).
- Protective sheath included.

Maverick Trail, Maverick Sport, Maverick Sport MAX

715001423

**\$129.99**



**GEAR RAIL**

- Sturdy gear rail design with C-clamps attached on the roll cage.
- Offers mounting points for the Stronghold Auto-Latch Mount or for the Universal Saw Press by Kolpin.
- Can hold up to two gun boots.
- Not compatible with the Gun Boot 6.0 Impact by Kolpin.

Maverick Trail, Maverick Sport, Maverick Sport MAX

715003703

**\$279.99**







**BAJA DESIGNS LEDS ARE DEVELOPED BY THE SCIENTISTS OF LIGHTING TO SHINE FARTHER AND SURVIVE BEYOND THE BEATEN PATH—ALL WITH A LIFETIME WARRANTY.**

**10" [25 CM] BAJA DESIGNS ONX6 LED LIGHT BAR**

- 108W light bar producing 12,460 lumens.
- Equipped with 6 Cree XM-L2 LEDs.
- Driving/Combo light pattern for smooth blend of light for both near field applications and distance.
- Dual intensity (high/low) settings plus strobe mode.
- Can be installed on Can-Am Front Bumpers, Sport Roof and Bimini Roof.
- Requires Baja Designs Light Power Cable.



**Maverick Trail, Maverick Sport, Maverick Sport MAX**  
710006819  
\$549.99

**BAJA DESIGNS XL SPORT LED LIGHTS**

- 26W per spot producing 3,150 lumens.
- Equipped with 4 Cree XP-G2 LEDs per spot.
- High Speed Spot features a longer and narrower beam focus for illumination farther down.
- Can be installed on Can-Am Front Bumpers, Sport Roof and Bimini Roof.
- Requires Baja Designs Light Power Cable.
- Dimensions: 4.5" x 4.5" (11.4 cm x 11.4 cm).
- Sold in pairs.



**Maverick Trail, Maverick Sport, Maverick Sport MAX**  
710006821  
\$499.99

**BAJA DESIGNS SQUADRON SPORT LED LIGHTS**

- 26W per spot producing 3,150 lumens.
- Equipped with 4 Cree XP-G2 LEDs per spot.
- Can be installed on Can-Am Front Bumpers, Sport Roof and Bimini Roof.
- Requires Baja Designs Light Power Cable.
- Wide cornering light pattern designed specifically for cornering, dust and/or fog conditions.
- Sold in pairs.
- Dimensions: 3" x 3" (7.6 cm x 7.6 cm).



**Maverick Trail, Maverick Sport, Maverick Sport MAX**  
710006820  
\$299.99

**BAJA DESIGNS XL80 LED LIGHTS**

- 80W per spot producing 9,500 lumens.
- Equipped with 4 Cree XHP50 LEDs per spot.
- Dual intensity (high/low) settings.
- Driving/Combo light pattern for smooth blend of light for both near field applications and distance.
- Can be installed on Can-Am Front Bumpers, Sport Roof and Bimini Roof.
- Requires Baja Designs Light Power Cable.
- Dimensions: 4.5" x 4.5" (11.4 cm x 11.4 cm).
- Sold in pairs.



**Maverick Trail, Maverick Sport, Maverick Sport MAX**  
710005041  
\$1,009.99

**12,460 LUMENS**

**10" [25 cm] ONX6 COMBO**

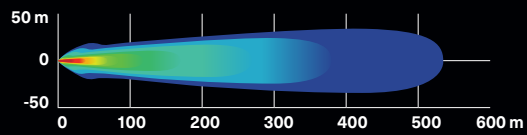

**3,150 LUMENS**

**XL SPORT SPOT**

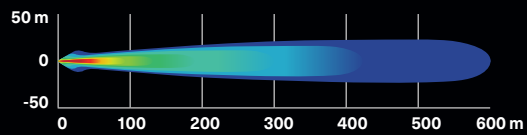

**3,150 LUMENS**

**SQUADRON SPORT WIDE CORNERING**

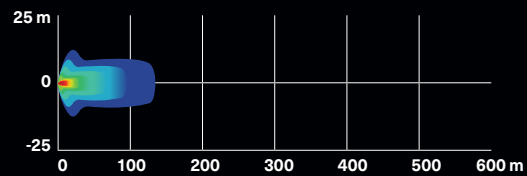

**9,500 LUMENS**

**XL80 COMBO**

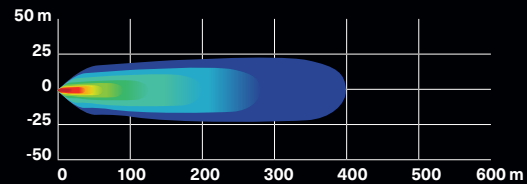

**39" [99 CM] DOUBLE STACKED LED LIGHT BAR (270 WATTS)**

- Equipped with 54 5W Cree LEDs.
- 24,300 lumens.
- Not compatible with Full Windshield, Flip Windshield and Can-Am Intrusion Bar.
- See table for mounting location and installation requirements.

**Maverick Trail, Maverick Sport, Maverick Sport MAX**  
715004007  
\$869.99

**24,300 LUMENS**

Lights up to more than 2900 ft (900 m) in front of the vehicle and around 115 ft (35 m) wide on each side.

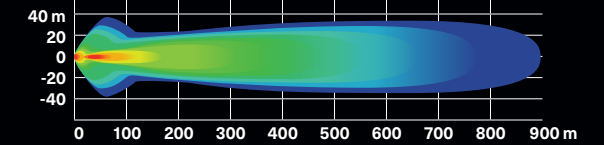

**15" [38 CM] DOUBLE STACKED LED LIGHT BAR (90 WATTS)**

- Equipped with 18 5W Cree LEDs.
- 8,400 lumens.
- Rugged and waterproof.
- EC compliant.
- See table for installation location and requirements.

**Maverick Trail, Maverick Sport, Maverick Sport MAX**  
715002934  
\$449.99



**8,400 LUMENS**

Lights up to more than 1900 ft (580 m) in front of the vehicle and around 65 ft (20 m) wide on each side.

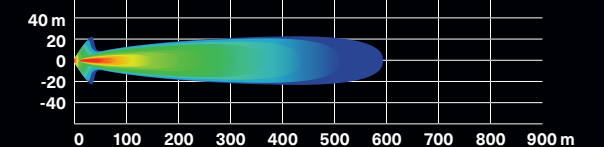

**10" [25 CM] DOUBLE STACKED LED LIGHT BAR (60 WATTS)**

- Equipped with 12 5W Cree LEDs.
- 5,400 lumens.
- Rugged and waterproof.
- Packs a big punch for its size.
- EC compliant.
- See table for installation location and requirements.

**Maverick Trail, Maverick Sport, Maverick Sport MAX**  
715002933  
\$359.99



**5,400 LUMENS**

Lights up to more than 1500 ft (460 m) in front of the vehicle and around 65 ft (20 m) wide on each side.

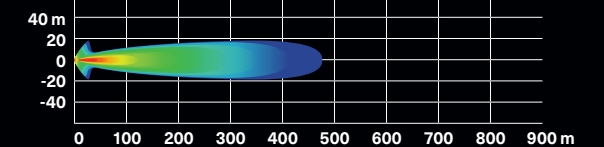

**4" [10 CM] ROUND LED LIGHTS (2 X 25 WATTS)**

- 25W LED spotlights.
- 1,800 lumens.
- Rugged and waterproof.
- Includes basic wiring and switch.
- Can-Am branded grill.
- Sold in pairs.
- Not EC compliant.
- See table for installation location and requirements.

**Maverick Trail, Maverick Sport, Maverick Sport MAX**  
715002935  
\$449.99



**1,800 LUMENS**

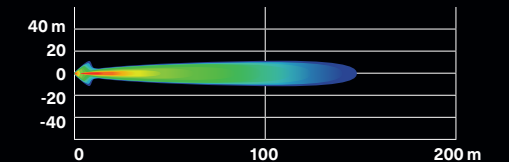



FLOOD THE BED WITH A STRONG LIGHT WHILE GRABBING CARGO, REVERSING, AND WORKING



3.5" (9 CM) LED FLOOD LIGHTS

**New REAR LIGHT POWER CABLE**

- (Not illustrated)
- Power cable that allows you to install rear cargo lights on your vehicle.
- Use in conjunction with the 3.5" (9 cm) LED Flood Lights (2 x 14W) (sold separately).
- This set-up will illuminate your rear cargo area and surroundings.
- Sport Roof and Overhead Switch Panel (715003669) required.

**Maverick Trail, Maverick Sport, Maverick Sport MAX**  
715004910  
**\$59.99**

**New 3.5" (9 CM) LED LIGHTS (2 X 14W)**

- 14W LED lights producing 1,260 lumens each.
- Equipped with 6 high power LEDs in a heavy-duty die cast aluminum housing.
- Features 2 attachment points — if one attachment point fails due to a collision, rotate to the next channel point and re-mount the light.
- Sold in pairs.
- EC compliant.

**Maverick Trail, Maverick Sport, Maverick Sport MAX**

**LED DRIVING LIGHTS**

- Spot lens for a narrow and long light beam spread, ideal when driving at higher speeds.

715003666

**\$249.99**

**LED FLOOD LIGHTS**

- Flood lens for a wide light beam spread, ideal for working applications like plowing or for cornering, dusty or foggy riding conditions.

715003665

**\$249.99**



1,260 LUMENS

**LED DRIVING LIGHTS**

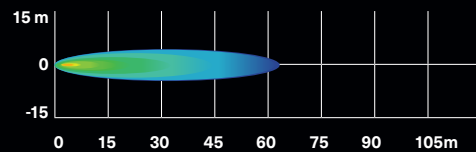

**LED FLOOD LIGHTS**

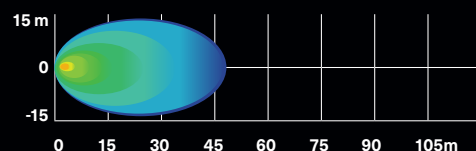

**BUILD YOUR LIGHTING SYSTEM. REFER TO PAGE 47**

39" (99 CM) DOUBLE STACKED LED LIGHT BAR

15" (38 CM) DOUBLE STACKED LED LIGHT BAR

BAJA DESIGNS XL SPORT LED LIGHTS

**BUILD YOUR LIGHTING SYSTEM IN 3 EASY STEPS**

1 CHOOSE YOUR MOUNT POINT	2 CHOOSE YOUR LIGHTS									
	BAJA DESIGNS LIGHTS				CAN-AM LIGHTS					
	10" (25 CM) LED LIGHT BAR	XL SPORT LED LIGHTS (SOLD IN PAIRS)	SQUADRON SPORT LED LIGHTS (SOLD IN PAIRS)	XL80 LED LIGHTS (SOLD IN PAIRS)	10" DOUBLE STACKED LED BAR	15" DOUBLE STACKED LED BAR	39" DOUBLE STACKED LED BAR	4" ROUND LED LIGHTS (SOLD IN PAIRS)	3.5" SPOT OR FLOOD LED LIGHTS (SOLD IN PAIRS)	
	Consult p.44 for more information on these lights.				Consult p.45-46 for more information on these lights.					
<b>TRAIL BUMPER &amp; RANCHER BUMPER</b>	NA	710005287 PLUS 715002884 (Power Cable)	710006820 PLUS 715002884 (Power Cable)	710005041 PLUS 715003729 (Power Cable)	715002933 PLUS 715003670 (Mounting Kit)	NA	NA	715002935 (4" Round), 715003665 (3.5" Flood) or 715003666 (3.5" Spot) PLUS 715003670 (Mounting Kit)		
<b>DRAGONFIRE RACING FRONT BUMPER</b>	NA	NA	NA	NA	715002933 PLUS 715003670 (Mounting Kit)	NA	NA	715002935 (4" Round), 715003665 (3.5" Flood) or 715003666 (3.5" Spot) PLUS 715003670 (Mounting Kit)		
<b>LONESTAR RACING FRONT BUMPER</b>	NA	NA	NA	NA	NA	NA	NA	NA	NA	
<b>SPORT ROOF &amp; BIMINI ROOF</b>	710004881 PLUS 715002885 (Power Cable) *Optional: Overhead Switch Panel 715003669	710005287 PLUS 715002884 (Power Cable) *Optional: Overhead Switch Panel 715003669	710006820 PLUS 715002884 (Power Cable) *Optional: Overhead Switch Panel 715003669	710005041 PLUS 715003729 (Power Cable) *Optional: Overhead Switch Panel 715003669	715002933 PLUS 715003669 (Overhead Switch Panel)	715002934 PLUS 715003669 (Overhead Switch Panel)	715004007 PLUS 715005822 (Mounting Kit) *Optional: Overhead Switch Panel 715003669	715002935 (4" Round), 715003665 (3.5" Flood) or 715003666 (3.5" Spot) PLUS 715003669 (Overhead Switch Panel)		
<b>TOP ROLL CAGE &amp; DRAGONFIRE ALUMINUM ROOF</b>	NA	NA	NA	NA	NA	NA	715004007 PLUS 715005822 (Mounting Kit)	NA	NA	
<b>LONESTAR RACING ALUMINUM ROOF</b>	NA	NA	NA	NA	NA	NA	715004007 PLUS 715004877 (Light Mounts) & 715005822 (Mounting Kit)	NA	NA	

**3 ORDER**

**ORDER ALL PART NUMBERS IN INTERSECTING BOX**

\*NOTE: When installing more than one light kit, additional Light Power Cable or Mounting Kit is required.

\*All lights are intended for Off-Road use only.

**MOUNTING KIT FOR 39" (99 CM) LED LIGHT BAR**

- (Not illustrated)
- Required for installation of the 39" (99cm) Double Stacked LED Light Bar.
- Includes wiring and support bracket.

**Maverick Trail, Maverick Sport, Maverick Sport MAX**

715005822  
**\$124.99**

**LIGHT POWER CABLE**

- (Not illustrated)
- Power cable for installation of compatible Can-Am light kits on Front Bumpers.

**Maverick Trail, Maverick Sport, Maverick Sport Max**

715003670  
**\$59.99**

**BAJA DESIGNS LIGHT POWER CABLE**

- (Not illustrated)
- Required for installation of Baja Designs LED lights onto roof or bumper.

**Maverick Trail, Maverick Sport, Maverick Sport MAX**

10" (25 cm) Baja Designs OnX6 LED Bars	Baja Designs XL Sport LED Lights & Baja Designs Squadron Sport LED Lights	Baja Designs XL80 LED Lights
715002885	715002884	715003729
<b>\$99.99</b>	<b>\$74.99</b>	<b>\$109.99</b>





CAN-AM LED SIGNATURE LIGHTS

**CAN-AM LED SIGNATURE LIGHTS**

- Add style with a more aggressive look.
- Use bright and energy efficient LEDs.
- Do not give additional lighting for driving.
- Standard on DPS models.

**Maverick Trail, Maverick Sport, Maverick Sport MAX**  
715003673  
\$249.99



**LED HEADLIGHT KIT**

- The headlights in this upgrade kit draw a maximum of 40W (2 x 20W) of power while providing brighter light output.
- Lower power consumption and longer lasting than standard halogen bulbs.

**Maverick Trail, Maverick Sport, Maverick Sport MAX**  
715003667  
\$839.99



**ROOF TAIL LIGHT**

- Roof mounted tail and brake light increases your visibility for following vehicles.
- Uses bright and energy efficient LEDs.
- Sport Roof (715003659/Max: 715004704) is required for installation.

**Maverick Trail, Maverick Sport, Maverick Sport MAX**  
715003668  
\$224.99



**LONESTAR RACING MOUNTS FOR 39" (99 CM) DOUBLE STACKED LED LIGHT BAR**

- Low profile mounts allowing for the installation of the 39" (99 cm) Double Stacked LED Light Bar on the Lonestar Racing Aluminum Roof (sold separately).

**Maverick Trail, Maverick Sport, Maverick Sport MAX**  
715004877  
\$309.99



**DOME LIGHT**

- LED array integrates perfectly with vehicle.
- Wiring included.
- Can be installed on cage, Sport Roof or All-Terrain Trunk Cover.

**Maverick Trail, Maverick Sport, Maverick Sport MAX**  
715002455  
\$84.99



# AUDIO & COMMUNICATION SYSTEMS

Your ride, your trail, your tunes: Pump up the volume wherever you may roam with these ruggedly-engineered audio accessories!

- FIT & COMPATIBILITY
- QUALITY & RELIABILITY
- STYLE & VISION

**100%**  
integrated

Our Audio Systems are designed to seamlessly integrate with the style, fit, finish, and capability of your Maverick Sport and Maverick Trail.



**COMPLETE WET SOUNDS AUDIO SYSTEM**

Designed to be Can-Am tough during the most demanding riding, this powerful system rocks high-fidelity sound... everywhere.



**Make 'em say "What!?"**

Both audio systems are powered by a 200W integrated amplifier with D-Bass Tech for punchy low end sound and strong volume.



**NEW ELECTRONIC DEVICE HOLDER**

Connect to your Wet Sounds Audio System or Rugged Radios Intercom System to easily play music from your smartphone or tablet.





### COMPLETE WET SOUNDS AUDIO SYSTEM

- Orchestrated for outstanding sound quality and the playlists of champions.
- Built-in 200W amplifier with D-Bass Tech for improved low end bass response.
- Built-in Bluetooth connectivity with source control.
- Aux input allows for use with non-Bluetooth devices.
- Turns itself off after 10 minutes of inactivity to save battery power.
- Designed to be Can-Am-tough in the most demanding riding conditions.
- Includes 4.5" (11.4 cm) front and 6.5" (16.5 cm) rear-roll-cage mounted stereo speakers and console integrated backlit control panel.

**Maverick Trail, Maverick Sport, Maverick Sport MAX**

715003672

**\$939.99**



**EXPERT CHOICE**

The only thing that'll roar just as hard as your Rotax engine, this 4-speaker system rocks!

### WET SOUNDS STEALTH 6 ULTRA HD CAN-AM EDITION SOUND BAR

- Built-in 200W amplifier with D-Bass Tech for improved low end bass response.
- Full range speaker array plus additional titanium dome tweeters for dynamic output and performance.
- HD High Output drivers with new composite high-stiffness frames.
- Built-in Bluetooth connectivity with source control.
- RF wireless remote for full control from steering wheel cradle.
- Aux input allows for use with non-Bluetooth devices.
- Turns itself off after 10 minutes of inactivity to save battery power.
- Backlit control panel.
- 2V line-output allows for hooking up another sound bar or adding an external amplifier and speakers.
- IP67 rated for better protection against the elements.
- Powder coat finish for extra durability and resistance to the elements.
- Requires Sound Bar Mount Kit (715004745).

**Maverick Trail, Maverick Sport, Maverick Sport MAX**

710006028

**\$739.99**



### SOUND BAR MOUNT KIT

(Not illustrated)

- Required Mount Kit for the Wet Sounds Stealth 6 Ultra HD Can-Am Edition Sound Bar (710006028).

**Maverick Trail, Maverick Sport, Maverick Sport MAX**

715004745

**\$99.99**

### RUGGED RADIOS CAR-TO-CAR SYSTEM

- Perfect for communicating with friends and family on group rides.
- Push-to-talk button conveniently mounted on the steering wheel.
- Includes radio mounting bracket, helmet speaker, mic kit and base charger.
- May be synched with the Rugged Radios Intercom System (715002891).
- 2-4 mile range.

**This kit includes:**

- RH-5R Rugged Radios 5-Watt Dual Band Handheld Radio
- Helmet Speaker/Mic Kit
- Push-to-talk buttons
- Mounting bracket
- Base station charger

**Maverick Trail, Maverick Sport, Maverick Sport MAX**

715003440

**\$419.99**



### RUGGED RADIOS HELMET HEADSET KIT FOR REAR PASSENGERS

- Additional 12' (3.7 m) cables and Helmet Speaker/Mic Kits to upgrade your 2-person intercom system into a 4-person system.

**With Rugged Radios Intercom System**

715004380

**\$249.99**

### New ELECTRONIC DEVICE HOLDER

- A great in-ride entertainment system platform.
- Robust injected-polypropylene construction allows for right fit and easy installation.
- Adjustable unit safely holds most tablets and smartphones measuring between 5.1" (13 cm) and 10" (25.4 cm) (with protective case).
- Complements perfectly the Wet Sounds audio systems or Rugged Radios Intercom System to play music with your device.
- Allows the installation of Garmin Montana 680T GPS.
- Integrated storage (2.5 Gal (9.5 L) capacity) with access to the dash 12V outlet for device charging.
- Integrated mounting location for RAM mounts.
- Not compatible with Defrost, Heat & Ventilation System (715003678).

**Maverick Sport, Maverick Sport MAX, Maverick Trail**

715005212

**\$189.99**



Easily, securely put your smartphone or tablet within reach for mapping, music, and more.



### RUGGED RADIOS INTERCOM SYSTEM

- Specifically designed to facilitate clear in-vehicle communication between driver and passenger(s).
- Expandable to 4 people.
- Includes music port for enjoying your favorite tunes.
- Seamless integration with in-dash switch panel.
- May be synched with the Rugged Radios Car-To-Car System (715003440).

**Maverick Trail, Maverick Sport, Maverick Sport MAX**

715002891

**\$739.99**





# HEATED ACCESSORIES

Our heated accessories work hard to keep you comfortable in the coldest weather.



**FIT &  
COMPATIBILITY**



**QUALITY &  
RELIABILITY**



**STYLE &  
VISION**

## FLICK THE SWITCH

Can-Am heated accessories are seamlessly integrated with your Maverick Sport or Maverick Trail and include an **in-dash switch** for easy On/Off and temperature control.



## SEAMLESS WARMTH HEATED SEAT COVER



### Simple installation

Once the wires are passed, you just need to slip the cover over the seat cushion.



### Best fit & finish

Nothing else fits, looks, performs, and lasts like Can-Am factory-designed accessories.



## LET THERE BE HEAT

The **Defrost, Heat & Ventilation System** offers three (3) ventilation speeds, dashboard temperature controls, and five (5) vents positioned for maximum defrost and complete interior comfort.

# ELECTRICAL & ELECTRONIC ACCESSORIES

## DEFROST, HEAT & VENTILATION SYSTEM

- Best integrated system on the market with 3-ventilation speed and in-dash adjustable temperature.
- Adjustable/directional vents.
- 5 vents specially positioned for better windshield defrosting and passenger comfort.
- Automotive-style heater core and fan for best heating performance.

**Maverick Trail, Maverick Sport, Maverick Sport MAX**

715003678

**\$1,159.99**



## HEATED STEERING WHEEL

- Ruggedly-constructed steering wheel designed to withstand cold conditions while channeling heat directly to your hands.
- Perfect for making hand mobility and grip readily available, e.g. hunting, manual farming.
- Replaces stock steering wheel.
- This kit includes the heated steering and in-dash switch.
- Heated Accessories Wiring Harness (710005757) is required.
- Draws a maximum of 45W and 3.2A at 13.5V.

**Maverick Trail, Maverick Sport, Maverick Sport MAX**

715004283

**\$469.99**



**EXPERT  
CHOICE**

Get a grip: Here's the ultimate comfort in cold conditions.

## HEATED SEAT COVER

- Made of rugged vinyl, this heated seat cover delivers chill free riding comfort.
- Ergonomically designed to fit snugly over the seat, it is also easy to install and remove.
- High/Low temperature settings allow you to control the desired degree of warmth.
- This kit includes the heated seat cover and in-dash switch.
- Heated Accessories Wiring Harness (710005757) is required for front seats installation and harness 715006004 is required for rear seats installation.
- Draws a maximum of 25W and 1.8A at 13.5V.

**Maverick Trail, Maverick Sport, Maverick Sport MAX**

715004501

**\$249.99**



## SEAT HEATER

- 30W seat heater delivers chill free riding comfort.
- Hi/Low temperature settings allow you to control the desired degree of warmth.
- This kit includes one carbon fiber seat heater, foam sheet and in-dash switch.
- Installs directly in the original seat cushion.
- Heated Accessories Wiring Harness (710005757) is required for front seats installation and Harness (715006004) is required for rear seats installation.

**Maverick Trail, Maverick Sport, Maverick Sport MAX**

715005112

**\$149.99**



## HEATED GRAB BAR COVER

- Made tough to hold up to the stresses of rough riding, this heated cover will keep your passenger's hands warm and securely gripped during long cold outings.
- Easy to install and remove.
- This kit includes the heated grab bar cover and in-dash switch.
- Heated Accessories Wiring Harness (710005757) is required.
- Draws a maximum of 25W and 1.8A at 13.5V.

**Maverick Trail, Maverick Sport, Maverick Sport MAX**

715004500

**\$244.99**



## **New** HEATED SEAT HARNESS FOR MAX MODEL

(Not illustrated)

- For rear installed seat heater on Max models.

**Maverick Sport MAX**

715006004

**\$189.99**

## HEATED VISOR OUTLET

- Strategically positioned on vehicle to maintain your agility.
- Optional visor outlet that delivers fog-free riding.
- Quick and easy installation.
- Sold individually.
- Heated Visor not included.

**Maverick Trail, Maverick Sport, Maverick Sport MAX**

715001246

**\$64.99**



## HEATED ACCESSORIES WIRING HARNESS

(Not illustrated)

- Electric harness required to hook up and operate heated accessories.
- Power up to 4 accessories: 2 hand accessories (grab bar/steering wheel) and 2 seat covers.

**Maverick Trail, Maverick Sport, Maverick Sport MAX**

710005757

**\$124.99**

## POWER CABLE

(Not illustrated)

- Brings power from the battery.
- Required for installation of some electrical accessories.

**Maverick Trail, Maverick Sport, Maverick Sport MAX**

715003094

**\$54.99**



### ADJUSTABLE LIGHTED WHIP FLAG

- A must for riding the dunes.
- 5W Cree LED.
- 5 colored lenses to allow personalization.
- Glow-through whip, quickly-removable and replaceable pole.
- Increases vehicle's visibility.
- Meets most dune-area requirements.
- Die cast aluminum base, acetal hand nut.
- Includes adjustable mounting brackets and wiring.

**Maverick Trail, Maverick Sport, Maverick Sport MAX**

715005437

**\$349.99**

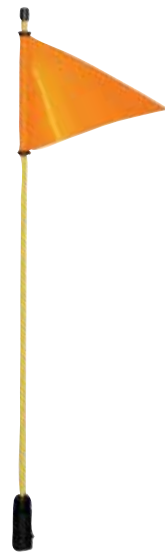

### BATTERY CHARGER/MAINTAINER

- Fully automatic 3 amp battery charger / maintainer.
- Keeps stored lead-acid batteries charged.
- Charges and maintains small batteries.
- Microprocessor controlled multi-stage charging for added precision, safety and battery life.
- Automatically detects 6 or 12 volt batteries.
- Float mode monitoring automatically maintains optimum battery charge.
- Reverse hook-up protection helps protect battery and charger from damage.
- Auto-voltage detection.
- Hook attachment hangs outside the work area for safety and convenience.
- Display/On button.
- Press the display button to show the charge progress.
- Energy efficient/eco friendly, meets the highest industry standards for energy efficiency.
- Content: 3 amp battery charger, clamp adapter, DC adapter, 24" fused ring leads harness with weather cap, owner's manual.

715005061

**\$69.99**



### OVERHEAD SWITCH PANEL

- Fully integrated overhead switch panel gives additional switch spots for electrical accessories.
- Required for Can-Am lights installation on the roof and for other top-mounted electrical accessories.
- Optional for Baja Designs lights.
- Requires Sport Roof or Bimini Roof with Sun Visor for installation.

**Maverick Trail, Maverick Sport, Maverick Sport MAX**

715003669

**\$249.99**



### JUMP STARTER

- IPX3 water-resistant and enclosed output ports.
- 4 LED battery indicators for easy read on battery charge level.
- Compact design, will conveniently fit in your backpack, glove box or any other storage compartment.
- Quickly starts vehicles in emergencies.
- Great for power sports, motorcycles and 4 and 6 cylinder vehicles.
- 2.4A + 1A/5V USB ports for fast charging of all USB devices, including smartphones, MP3 players and tablets.
- Smart cable provides protection against reverse polarity, short circuit, low voltage, high temperature and reverse charging.
- Built-in LED light (3 modes).
- Content: 300CA jump starter, SA858 smart cable clamp, MC-USB to USB charging cable, travel bag, user manual.

715005062

**\$144.99**



### **New** QUICK CONNECT CABLE WITH BATTERY INDICATOR

- Quickly and easily connect and charge different batteries with your charger.
- 3-color LED indicator provides constant battery health indication.
- Sold individually.

715006055

**\$24.99**



### DIGITALLY ENCODED SECURITY SYSTEM (D.E.S.S.™) KEYS

- Top-security anti-theft protection for your vehicle.
- Encrypted chip technology restricts access to your vehicle's electronic ignition system.
- One vehicle/One code.
- A vibration/shock-resistant ball-and-socket design that ensures a reliable connection.
- Comes with 3 programmable keys:
  - Work key: limits vehicle speed to 40 kph (25 mph) but does not limit engine torque.
  - Normal key: limits vehicle speed to 70 kph (44 mph) and 50% torque reduction.
  - Performance key: No restrictions.

**Maverick Trail, Maverick Sport, Maverick Sport MAX**

715002458

**\$249.99**



### QUICK CONNECT BATTERY CABLE

- Quickly and easily connect and charge different items with your charger.
- Included in the Battery Charger/Maintainer (715005061).
- Sold individually.

715005408

**\$9.99**



### 30AH BATTERY HOLDER

- Fixation plate designed to hold the 30ah Battery.
- 30ah Battery (515176151) sold separately.

**Maverick Trail, Maverick Sport, Maverick Sport MAX**

715004431

**\$59.99**



### DUAL MODE SWITCH

- Switches quickly and conveniently between normal and eco modes.
- Eco mode increases fuel economy.
- In-dash plug-and-play mount.
- Standard on DPS models.

**Maverick Trail, Maverick Sport, Maverick Sport MAX**

715004736

**\$34.99**



### 12V POWER OUTLET

- 12V accessories outlet.
- Easy plug-in harness included.

**Maverick Trail, Maverick Sport, Maverick Sport MAX**

715003846

**\$59.99**



### USB POWER OUTLET KIT

- Recharges your electronic devices while riding\* (smartphone, MP3, heating gear, etc.).
- Dual port USB connectors.
- \* The power outlet is not capable of recharging all device types while riding.

**Maverick Trail, Maverick Sport, Maverick Sport MAX**

219400510

**\$35.99**



### GARMIN MONTANA® 680T GPS

- Rugged and waterproof, the Montana 680T is element-proof.
- 4" dual-orientation, sunlight-readable touchscreen and glove-friendly touchscreen display, to give you vivid colors and high-resolution images.
- 8-megapixel autofocus camera automatically geotags photos.
- Tracks both GPS and GLONASS satellites for improved positioning and typically faster fixes.
- Preloaded TOPO maps, plus 1-year BirdsEye Satellite Imagery subscription.
- 3-axis compass with barometric altimeter.
- Specific GPS cradle included (vehicle mounting kit required).
- Includes a preloaded map for US.

**Maverick Trail, Maverick Sport, Maverick Sport MAX**

715002830

**\$769.99**

#### European Version

- EC compliant.
- Includes preloaded European recreation map.

715003456



### CANADIAN MAP FOR GARMIN MONTANA 680T GPS

(Not illustrated)

- Additional and readily-programmable Canadian basemap for Garmin Montana 680T GPS system.
- Requires Garmin Montana 680T GPS (715002830).

**Maverick Trail, Maverick Sport, Maverick Sport MAX**

710005065

**\$149.99**

### CGX3 CAMERA

- 160° wide angle lens.
- Resolution options: From 3MP up to 20MP and VGA.
- Video resolutions available: 2.7K at 30 frames per second (FPS), 720P at 120/60/30 FPS, 1080P at 60/30 FPS and VGA at 240 FPS.
- Record videos in 4K UHD at 24 FPS, 2.7K QHD at 30 FPS and 720P at 120 FPS.

9700130090

**\$399.99**

- Memory: Class 10 32GB Micro SD card.
- 2" (5 cm) capacitive touchscreen.
- Li-ion battery capacity of 1050mAh, working time of 1/1.5 hours and charging time of 3 hours (2 batteries included).
- WiFi function remotely operates up to 10-15 meters with mobile devices and Cyclops app for Android and iOS.

- Waterproof up to 10 meters without a case.
- Features modes such as invert, time lapse, high speed and loop recording, motion detection, capture (while recording a video), burst and anti-sharing.
- Comes with 8 mounting accessories.



### CGX3 GIMBAL CAMERA STABILIZER

(Not illustrated)

- 3-axis full 360-degrees precision: Eliminates shaky video and allows you to easily shoot pro-quality, cinematic-like footage with your Action Camera.
- Independent app to control the gimbal.
- Built-in Bluetooth 4.0.
- Compatible with iOS 8.0 and Android 4.4 or above.
- Rechargeable battery.
- Rugged, full aluminum alloy.
- 5-way joystick and multi-function button for flexible operations and convenient switch.

9700160090

**\$349.99**

### CGX3 POWER STICK MOUNT

(Not illustrated)

- 5200mAh of continuous power in your hand, when you need it.
- Rubberized silicone handle for comfort and grip.
- Power indicator light to let the user know when the battery is running low.
- Includes power hand grip, long screw, convert tripod mount, phone clip mount, USB mini cord, USB micro cord and adjustable strap.

9700100090

**\$54.99**

### CGX3 LED LIGHT

(Not illustrated)

- Wide-Angle 300 Lumen Max. (5500K-6000K) by 3 LEDs.
- Waterproof, attachable light.
- Three modes of light: High, Low, Flashing.
- Rechargeable battery: 1050mAh.

9700200090

**\$59.99**

### CGX3 SELFIE STICK

(Not illustrated)

- Easily take photos or record videos with the CGX3 Selfie Stick.
- This selfie stick is made tough for any sport or activity.

9700170090

**\$24.99**





## WARN<sup>+</sup> VRX

- Extreme IP68-rated waterproof sealing keeps the elements out.
- Durable all-metal construction.
- Black powder-coated finish and stainless steel fasteners for corrosion resistance.
- Robust new clutch design based on 70+ years of WARN 4WD hub lock know-how.
- Load-holding brake for great control.
- Smooth and reliable all-metal three-stage planetary gear train.
- Dash-mounted rocker control and corded remote.
- Limited lifetime warranty (mechanical), 3-year warranty (electrical).
- Pulling strength capability of 4,500 lb (2,041 kg).

### New WARN VRX 45 WINCH

- 50 ft. of 1/4" (15 m of 6.3 mm) wire steel cable.
- Roller fairlead.

Maverick Trail, Maverick Sport, Maverick Sport MAX

715006110

\$649.99



### New WARN VRX 45-S WINCH

- 50 ft. of 1/4" (15 m of 6.3 mm) synthetic rope.
- Cast aluminum fairlead.

Maverick Trail, Maverick Sport, Maverick Sport MAX

715006111

\$779.99



## CAN-AM HD

- Ergonomic clutch handle.
- Rugged all-steel gears and bushings for more torque and durability.
- Automatic 100% load-holding brake.
- Sealed solenoid for all-weather protection.
- Weather sealed corded remote and dash mounted switch.
- EC compliant.

### New CAN-AM HD 4500 WINCH

- Pulling strength capability of 4,500 lb (2,041 kg).
- 43 ft. of 15/64" (13.1 m of 6.3 mm) wire steel cable.
- Heavy-duty 4-way roller fairlead.
- Winch Electrical Harness (715003777) is required for installation on Base and DPS models.

Maverick Trail, Maverick Sport, Maverick Sport MAX

715006416

\$379.99



### New CAN-AM HD 4500-S WINCH

- Pulling strength capability of 4,500 lb (2,041 kg).
- 50 ft. of 1/4" (15.2 m of 6.35 mm) synthetic rope.
- Corrosion-proof aluminum hawse fairlead.
- Winch Electrical Harness (715003777) is required for installation on Base and DPS models.

Maverick Trail, Maverick Sport, Maverick Sport MAX

715006417

\$519.99



### CAN-AM HD HAWSE FAIRLEAD

- A must when upgrading your winch with a synthetic cable, this corrosion-proof aluminum hawse fairlead will prevent the cable from snapping in a corner of a roller fairlead and from wearing prematurely due to the rough surface of the worn roller guide.
- Must be used with synthetic cables only.

Can-Am HD winch

715006426

\$59.99



### WARN HAWSE FAIRLEAD

- Double-powder-coated construction.
- Required to use the Synthetic Winch Cable (715001118) on Warn winches.
- To be used with synthetic winch cables only.

With Warn winch

705204567

\$119.99



### WIRED REMOTE CONTROL

- This kit allows winch owners to add the hand-held remote to vehicles with a stock winch.
- OEM stock winch and Wired Remote Control are sold separately.
- EC compliant.

Can-Am HD winch

Remote control (715007050)

and connection socket are included.

715006504

\$26.99

Warn winch

Harness (710001023) is required to use remote control on a vehicle with a factory installed winch.

710001002

\$74.99



### WIRELESS REMOTE CONTROL

- The system is quick and easy to install, thanks to a wiring harness with an integrated antenna and all necessary mounting hardware.
- Allows you to operate your winch from anywhere within a 50' (15.2 m) radius, increasing your recovery options.
- All components are weatherproof.

With Warn winch

715002542

\$234.99



### WINCH ELECTRICAL HARNESS

(Not illustrated)

- Required for winch installation on Base and DPS models.

Maverick Trail, Maverick Sport, Maverick Sport MAX

715003777

\$84.99

### SYNTHETIC WINCH CABLE

- 50' of 7/32" (15.2 m of 5.5 mm) synthetic cable for Warn winch.
- Warn Hawse Fairlead (705204567) is required when upgrading to a synthetic cable to avoid damage and premature wear of the cable.

With Warn winch

715001118

\$174.99

- 50 ft. of 3/16" (15.2 m of 4.8 mm) synthetic cable for winches.
- Hawse Fairlead (715006426) required when upgrading to a synthetic cable to avoid premature cable damage and wear.

With Can-Am HD winch

715006430

\$154.99



### WIRE ROPE REPLACEMENT

- 55' of 7/32" (16.8 m of 5.5 mm) wire rope for Warn winch kit.
- 47 ft. of 1/4" (14.3 m of 6.3 mm) wire rope.
- 4,500 lb (2,041 kg) pulling strength.

With Warn winch

715001117

\$84.99

With Can-Am HD winch

705014978

\$24.99



### SYNTHETIC CABLE EXTENSION

- Lightweight 1/4" (6.3 mm) diameter, easy to handle and won't rattle in cargo box.
- Easily attaches to winch cable to provide additional 50' (15.2 m) of distance.
- 4,500 lb (2,041 kg) single line capacity.

Maverick Trail, Maverick Sport, Maverick Sport MAX

715001120

\$174.99



### X RC / X MR FRONT TOW HOOK

- Offers a solid place to hook onto in case towing is needed.
- Allows you to attach most straps and hooks.
- Made of rugged 1/8" (3 mm) steel plate and 7/16" (11 mm) steel hook tube.
- Standard on Maverick X rc and X mr models.

Maverick Trail, Maverick Sport, Maverick Sport MAX

715005229

\$134.99



### FRONT RECEIVER HITCH

- Heavy-duty 1,500 lb (680 kg) towing capacity 2" (5 cm) receiver hitch.
- Perfect for precision towing in small spaces.

Maverick Trail, Maverick Sport, Maverick Sport MAX

715003642

\$134.99





**SMART  
LOK™**  
TECHNOLOGY

## GRIP LIKE NEVER BEFORE

Can-Am exclusive: Respond to off-road conditions like never before with 4WD powered by Smart-Lok Technology.

Smart-Lok is the most advanced off-road differential at your command. It's a fully lockable on-the-fly front differential with electronically-controlled automatic modes that always returns maximum traction in every condition, period.



### 1 START WITH THE SMART-LOK DIFFERENTIAL

#### SMART-LOK™ DIFFERENTIAL

- Can-Am-exclusive Smart-Lok™ technology constitutes a true full lockable on-the-fly front differential with electronically-controlled automatic modes.
- Choose your differential settings according to your riding need: "2x4" for rear wheel traction only, "4x4 Front Diff Lock" for a fully locked 4 wheel drive, and "4x4 Smart Modes" that offer preset, intelligent calibrations for your type of riding.
- Using multiple input sources, "Smart Modes" will instantaneously engage locking with the right load at the right moment to procure maximum traction while retaining low-speed maneuverability, allowing for optimal placement and a feeling of confidence.
- The Smart-Lok Kit comes standard with the Trail Mode.
- Mud, Rock and Trail Activ modes can be added by installing an additional Smart Mode Module (sold separately) to fine-tune your riding environment.
- Requires Performance Half Shafts (2x) and Front Differential Kit for installation.

Maverick Trail, Maverick Sport, Maverick Sport MAX

705402371

\$1,769.99

### 2 GET THE SMART-LOK INSTALLATION KIT & PERFORMANCE HALF SHAFT

Both are required to install the Smart-Lok™ Differential Kit.

#### SMART-LOK™ INSTALLATION KIT

(Not illustrated)

- Includes all necessary hardware and wiring for Smart-Lok Differential installation.

Maverick Trail, Maverick Sport, Maverick Sport MAX

715005330

\$399.99

#### PERFORMANCE HALF SHAFT

- High-performance design ideal for off-road use, with superior wheel power and acceleration for racing, dunes and desert riding.
- Includes CVs, Shaft and Boots with the best suited geometry for your Can-Am vehicle.

Maverick Trail

705402423

\$249.99

Maverick Sport, Maverick Sport MAX

705402281

\$249.99



THE SMART-LOK  
KIT COMES WITH  
THE TRAIL MODE  
MODULE.

### 3 FINE-TUNE YOUR RIDING ENVIRONMENT WITH A SMART MODE MODULE (OPTIONAL)

These modules allow you to add the **Mud, Rock or Trail Activ** Smart Mode to vehicles equipped with the Smart-Lok™ Differential Kit. Only one Smart Mode Module can be installed at a time.



- Designed to deliver superior traction in the deepest mud holes.
- When high engine torque and/or slippage is detected, Smart-Lok™ will fully lock the front end.
- The system will stay locked until throttle release.

#### MUD SMART MODE MODULE

Models with Smart-Lok™ Differential

715005282

\$174.99



- Designed to help cross challenging rocks.
- When high engine torque is detected at low vehicle speed, Smart-Lok™ will progressively lock the front end and will stay engaged until throttle release to prevent wheel slippage and provide optimal traction.
- The progressive engagement allows for easier steering when maneuvering the vehicle.

#### ROCK SMART MODE MODULE

Models with Smart-Lok™ Differential

715005283

\$174.99

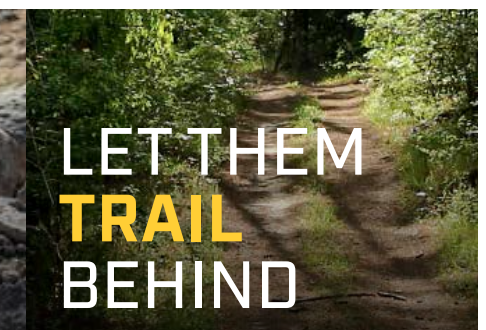

- Designed for aggressive riding delivering the ultimate cornering precision.
- When high engine torque and/or an increase in vehicle speed is detected, Smart-Lok will progressively engage the front end and maintain it engaged until throttle release or vehicle speed reduction.
- The progressive engagement allows for lower smooth steering effort.

#### TRAIL ACTIV SMART MODE MODULE

Models with Smart-Lok™ Differential

715005284

\$174.99





**YOSHIMURA SLIP-ON EXHAUST**

- Developed in collaboration with Yoshimura.
- Made from 304-grade stainless steel.
- Sporty sound from a lighter than stock muffler.
- USDF/USDA approved spark arrester.
- EPA compliant.
- Not EC compliant.

**Maverick Trail, Maverick Sport**  
(except models with 1000R engine)

715003716

**\$799.99**

**Maverick Sport (with 1000R engine),  
Maverick Sport MAX**

715004452

**\$999.99**



**EXPERT CHOICE**

Sound, engineering, and style: This exclusive slip-on Yoshimura exhaust roars like no other.

**SNORKEL KIT**

- Raises point of engine and CVT air intakes so vehicle can be semi-submersed in water/mud without taking in water to the engine.
- Not compatible with S&B Particle Separator, LinQ Pivoting Rack, Lonestar Racing Rear Intrusion Bar and all rear panels and windows.
- Standard on Maverick Sport X mr models.
- Not EC compliant.

**Maverick Trail, Maverick Sport,  
Maverick Sport MAX**

715003705

**\$569.99**



**S&B PARTICLE SEPARATOR**

- Uses vortex generators to eject approximately 94% of dust, snow, or silt before it even reaches your airbox.
- Helps maintain power, protect your engine and dramatically extend the life of your filter.
- Cage mounted with adjustable clamps.
- Not compatible with rear window.

**Maverick Sport (with 1000R engine),  
Maverick Sport MAX**

715004902

**\$519.99**

**Maverick Trail, Maverick Sport**  
(except models with 1000R engine)

715004422

**\$519.99**



**EMERGENCY KIT**

- Complete emergency kit provides all essential equipment and supplies to get out of most unfavorable situations powersport enthusiasts can find themselves in.
- Includes: Jumper Cables, Air Compressor, Tire Repair Kit, Ratchet Tie-Down, Duct Tape, Tow Strap 3,300 lb (1,500 kg), Zip-Ties, Cloth Rags.

715004359

**\$164.99**



**New SNORKEL PRE-FILTER**

- Pre-filter specifically for snorkels.
- Adds extra protection to your engine in harsh riding conditions.
- Helps keep air filter cleaner.
- Filter blocks particles larger than 0.005" (0.13 mm).
- Necessary to maintain vehicle warranty when tracks are installed.

**Maverick Sport, Maverick Sport MAX,  
Maverick Trail**

715005598

**\$124.99**



**ENGINE & CVT PRE-FILTER KIT**

(Not illustrated)

- Adds extra protection to your engine and CVT in harsh riding conditions.
- Filter blocks particles larger than 0.005" (0.1 mm).
- Water repellent screen.
- Necessary to maintain the vehicle's warranty when tracks are installed.
- Recommended for winter riding conditions.

**Maverick Trail, Maverick Sport, Maverick Sport MAX**

715004290

**\$84.99**

**New HEAVY-DUTY SPRING KIT**

- This set of heavy-duty springs will stiffen your suspension.
- Perfect for reducing vehicle overall sag when shocks are under heavy demand: Heavy loading and hauling or for snow clearing.
- Complete kit of 4 springs.

**Maverick Trail, Maverick Sport,  
Maverick Sport MAX**

715004961

**\$369.99**



**FOAM AIR FILTER BY TWIN AIR<sup>†</sup>**

- The best choice for the harshest conditions.
- Multiple staged oiled filtering foam for superior dust retaining capacity with high air flow.
- Washable and reusable.

**Maverick Trail,  
Maverick Sport**  
(except models with 1000R engine)

715003630

**\$124.99**

**Maverick Sport,  
Maverick Sport Max**  
(models with 1000R engine)

715002895

**\$124.99**



**SHOCK COVERS**

(Not illustrated)

- Soft cover for shocks with ventilation holes.
- Eliminate dust and dirt intrusion into the shock cylinder, reducing risk of damage.
- Sold in pairs.

**Maverick Sport,  
Maverick Sport MAX**

715002368

**\$36.99**



# APACHE TRACK SYSTEMS

Each track has a specific purpose and is designed without compromise for work and play. Whether it's for deep snow riding, trail riding or for heavy loads, Apache tracks are akin to floating across the terrain.



**FIT & COMPATIBILITY**



**QUALITY & RELIABILITY**



**STYLE & VISION**



## WINTER TRACKS

## YEAR ROUND TRACKS

**SNOW**

**MIXED CONDITIONS**



## APACHE BACKCOUNTRY

Finally explore winter with no traction limitations and no compromise, thanks to the unmatched performance of Apache Backcountry track kits. Engineered to thrive in the deepest snow—for work or play. Don't let winter stand in the way.

P.63

## APACHE 360 LT

These track kits improve your vehicle's ground clearance and increase its contact patch with the terrain. Adapt your track setup to the conditions you'll be riding in and the purpose of your ride, with the Apache 360 LT system: our all-season, all-terrain masterpiece.

P.64

## WINTER TRACKS APACHE BACKCOUNTRY

GET THE MOST OUT OF YOUR CAN-AM VEHICLE THIS WINTER FOR ALL YOUR ENDEAVORS.

Explore without compromise. Ride on untouched trails, traveling deep into winter's embrace and you'll know: The same technology behind our world-renowned snowmobiles is at your command. With a larger contact patch, and more aggressive track design, travel beyond what you thought possible with the best snow performance.

COVERED BY A 1-YEAR WARRANTY



### APACHE BACKCOUNTRY TRACK SYSTEM

- Designed to deliver the best flotation level and deep-snow performance on the market.
- Contact patch is 23% bigger than the Apache 360 LT.
- Provides an impressive average ground clearance increase of 7" (18 cm), keeping the vehicle out of deep snow.
- Aggressive track design with 2" (5 cm) lug height for maximum traction on snow.
- Apache Backcountry Mounting Kit, Track DPS Module (715004707) (see p.64) and Engine & CVT Pre-Filter Kit (715004290) are required.
- For winter use only.

**Maverick Trail, Maverick Sport, Maverick Sport MAX**

715005247  
**\$5,829.99**

### APACHE BACKCOUNTRY MOUNTING KIT

- (Not illustrated)
- Required for installation of the Apache Backcountry Track System.
- Track DPS Module and Pre-Filter not included.
- Not compatible with HMWPE Front and Rear A-Arm Protectors.

**Maverick Trail**  
715004285  
**\$634.99**

**Maverick Sport, Maverick Sport MAX**  
715004834  
**\$649.99**

AVAILABLE AT YOUR LOCAL DEALERSHIP IN SEPTEMBER 2019

### RAIL ICE SCRATCHERS

- Provide additional lubrication in hard and icy conditions.
- Rail mounted, small, light.
- Design expands on coil concept to allow reversing without damage.
- Easily stored when not in use.

**Apache Backcountry Track System**  
860201728  
**\$109.99**

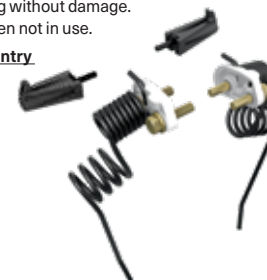

### IDLER WHEEL KIT

- Reduces drag and rolling resistance.
- Includes 2 wheels, brackets and hardware.
- Add up to 2 kits per rear track.
- Can extend slider life in hardened snow conditions.

**Apache Backcountry Track System, Rear tracks only**  
860201230 • 141 mm  
**\$74.99**



### SLIDERS WITH VESPEL<sup>†</sup> INSERTS

- Use DuPont Vespel inserts for less friction.
- Longer life.
- Can be cut to desired length.
- 8 needed per vehicle.
- Sold individually.

**Apache Backcountry Track System**  
503194815  
**\$104.99**

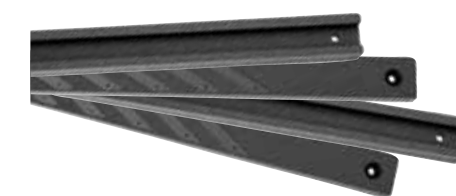



# YEAR ROUND TRACKS APACHE 360 LT

WORK & PLAY YEAR ROUND THROUGH MUD, SNOW, & ALL TYPES OF TERRAIN.

Rise above terrain, weather, and whole seasons with the Apache 360 LT track kit — the upgrade that takes the Can-Am experience to another level. Designed for superior traction and carrying heavier loads in soft terrain, the 360 LT track kit can be installed on ATV and SSV vehicles and used year round for exploring and completing tough tasks.

COVERED BY A 2-YEAR WARRANTY

ADDED GROUND CLEARANCE OF 4.5" (11.4 CM)

QUICK & EASY INSTALLATION



UNIQUE ADJUSTABLE CONTACT PATCH SYSTEM TO TACKLE THE TOUGHEST YEAR-ROUND CONDITIONS



RUBBER OVER MOLDED HEAVY-DUTY DOUBLE BEARING WHEELS AND OFFSET WHEEL SPACING REDUCE FRICTION AND VIBRATION WHILE ENSURING RELIABILITY

TOTAL GROUND SURFACE AREA OF 2,473.7 IN<sup>2</sup> (14,784 CM<sup>2</sup>)

## APACHE 360 LT TRACK SYSTEM

- Multifunctional tracks designed to support heavy loads and to fit on most Can-Am off-road vehicles.
- Extra contact patch adjustment for better performance over rough terrain.
- Average ground clearance increase of 4.5" (11.4 cm).
- 1" (2.5 cm) lugs in the front and 1.25" (3.2 cm) in the back.
- Apache Backcountry Mounting Kit, Track DPS Module (715004707) and Engine & CVT Pre-Filter Kit (715004290) are required.

**Maverick Trail, Maverick Sport, Maverick Sport MAX**  
715005103  
**\$4,924.99**

## APACHE 360 LT MOUNTING KIT

- (Not illustrated)
- Required for installation of the Apache 360 LT Track System.
  - DPS Module and Pre-Filter not included.

<b>Maverick Trail</b> 715004833 <b>\$604.99</b>	<b>Maverick Sport, Maverick Sport MAX (except X mr &amp; X rc models)</b> 715004755 <b>\$604.99</b>
---	---

Required to install the Apache Backcountry and Apache 360 LT Track Systems

### New SNORKEL PRE-FILTER

- Pre-filter specifically for snorkels.
- Adds extra protection to your engine in harsh riding conditions.
- Helps keep air filter cleaner.
- Filter blocks particles larger than 0.005" (0.13 mm).
- Necessary to maintain vehicle warranty when tracks are installed.



**Maverick Sport, Maverick Sport MAX, Maverick Trail**  
715005598  
**\$124.99**

### ENGINE & CVT PRE-FILTER KIT

- (Not illustrated)
- Adds extra protection to your engine and CVT in harsh riding conditions.
  - Filter blocks particles larger than 0.005" (0.1 mm).
  - Water repellent screen.
  - Necessary to maintain the vehicle's warranty when tracks are installed.
  - Recommended for winter riding conditions.

**Maverick Trail, Maverick Sport, Maverick Sport MAX**  
715004290  
**\$84.99**

### TRACK DPS MODULE

- (Not illustrated)
- Innovative DPS module that ensures speedometer accuracy and optimized steering assist, making for perfect track control and riding ease.
  - Required to install the Apache Track Systems.

**Maverick Trail, Maverick Sport, Maverick Sport MAX**  
715004707  
**\$159.99**

# PROMOUNT PLOWS

**FIT & COMPATIBILITY**

**QUALITY & RELIABILITY**

**STYLE & VISION**



The new ProMount lineup was created for both professional operators and enthusiasts looking to take their tool kit to the next level. Designed to work as efficiently as possible, Can-Am reimagined the plow from mount to blade.

## MOST EFFICIENT MOUNTING SYSTEM

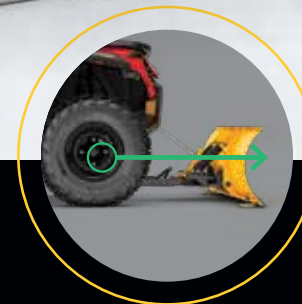

Underbelly mounting plate provides the **optimal angle of attack** for best push strength.



The forward mounted push frame provides **industry leading lift height**.



Low profile mounting plate has **little impact on ground clearance** and can be left installed year round.

## CONNECTS WITH A CLICK

Attachable in **FOUR EASY STEPS**, the Can-Am ProMount plow system is the fastest, easiest way to start plowing and get the job done—minimal effort for maximum result.



1 Drive straight toward the plow.



2 Attach the winch cable to the plow using a guiding hook/roller.



3 Lift the plow until it clips onto the mounting plate.



4 Remove the winch cable from the guide. You're ready to plow.



## CAN-AM PROMOUNT STEEL PLOWS

Consult your dealer for the best plow width. Made from 12-gauge steel and designed for efficient plowing, the ProMount steel blades are offered in multiple sizes to fit jobs large or small.

### CAN-AM PROMOUNT STEEL PLOW KITS

#### These kits include:

- Can-Am ProMount Steel Blade
- Push Frame with Quick-Attach System
- Mounting Plate

#### 54" (137 CM) BLADE

##### Maverick Trail

- 715005200 • Black
- 715005428 • Yellow

\$819.97

#### 60" (152 CM)

##### Maverick Trail, Maverick Sport, Maverick Sport MAX

- 715005201 • Black
- 715005434 • Yellow

\$849.97

#### 66" (168 CM) BLADE

##### Maverick Trail, Maverick Sport, Maverick Sport MAX

- 715005427 • Black
- 715005435 • Yellow

\$879.97



## CAN-AM PROMOUNT FLEX2 PLOWS

HMWPE (High Molecular Weight Polyethylene) technology gives Flex2 greater reliability, resistance to impact, and immunity to rust or deformation. Tough on jobs but flexible in the face of obstacles, the Flex2 blade simplifies work.

### CAN-AM PROMOUNT FLEX2 PLOW KIT

#### These kits include:

- Can-Am ProMount Flex2 Blade
- Push Frame with Quick-Attach System
- Mounting Plate

#### 60" (152 CM) BLADE

##### Maverick Trail, Maverick Sport, Maverick Sport MAX

- 715005202 • Black

\$969.97



### CAN-AM PROMOUNT STEEL BLADES

- Blades available individually to create your own kit.
- Compatible with Can-Am ProMount Blade accessories to further enhance plow versatility (some plow accessories are not compatible with 54" plows).

#### 54" (137 CM) BLADE

- Not compatible with ProMount Drift Cutters, Blade Extensions and Edge Markers.
- Clears 50" (127 cm) when plow is fully angled.
- Blade height of 14.75" (37 cm).

- Blade height of 14.75" (37 cm).

##### Fits ProMount Push Frame

- 715004472 • Black
- 715005316 • Yellow

\$299.99

#### 60" (152 CM) BLADE

- Clears 54" (137 cm) when plow is fully angled.
- Blade height of 17" (43 cm).

##### Fits ProMount Push Frame

- 715004202 • Black
- 715005317 • Yellow

\$329.99

#### 66" (168 CM) BLADE

- Clears 60" (152 cm) when plow is fully angled.
- Blade height of 17" (43 cm).

##### AVAILABLE IN AUGUST 2019 Fits ProMount Push Frame

- 715006337 • Black
- 715006338 • Yellow

\$389.99

#### New 72" (183 CM) BLADE

- Clears 66" (168 cm) when plow is fully angled.
- Blade height of 17" (43 cm).

##### AVAILABLE IN AUGUST 2019 Fits ProMount Push Frame

- 715004474 • Black
- 715006021 • Yellow

\$469.99

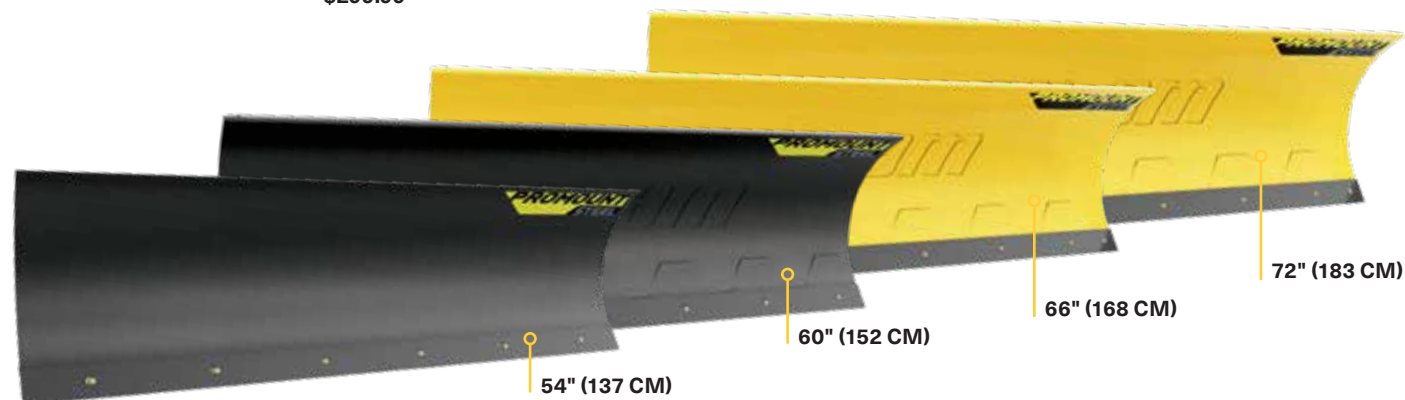

### CAN-AM PROMOUNT FLEX2 BLADES

- Blades available individually to create your own kit.
- Compatible with Can-Am ProMount Blade accessories to further enhance plow versatility.

#### 60" (152 CM) BLADE

- Clears 54" (137 cm) when plow is fully angled.

##### Fits ProMount Push Frame

- 715004203 • Black

\$449.99

#### New 72" (183 CM) BLADE

- Clears 66" (168 cm) when plow is fully angled.

##### AVAILABLE IN AUGUST 2019 Fits ProMount Push Frame

- 715004485 • Black

\$599.99



CREATE  
YOUR  
OWN KIT

by choosing any plow type/length that you'd like for your push frame. ProMount Push Frames are compatible with all the blades.



# YOUR JOB, YOUR CHOICE

Get a custom solution that truly fits the task at hand—with quality components and no cut corners. The ProMount push frame, mounting plate and blades are a universal system that can be adapted to your specific Can-Am and jobsite.

## CAN-AM PROMOUNT PUSH FRAME WITH QUICK-ATTACH SYSTEM

- Heavy-duty steel tubes designed to withstand the roughest use.
- Mid-mount carriage provides ultimate push strength and traction.
- Designed for maximum plow lift height.
- Features a self-aligning quick-attach system, an easy foot release pedal and an ergonomic handle for plow angle adjustment.
- Plow Roller Fairlead and Plow Limit Switch recommended to extend winch cable lifespan.
- Can-Am ProMount Mounting Plate required for installation.
- Blade swivels left or right, 5 positions.
- Large pin designed for easy blade rotation to eliminate dirt and snow buildup at pivot point.

**Maverick Trail, Maverick Sport, Maverick Sport MAX**  
715004339  
**\$399.99**



Compatible with all ProMount plows

## CAN-AM PROMOUNT PUSH FRAME EXTENSION

- 12" (30 cm) push frame extension.

**Maverick Trail, Maverick Sport, Maverick Sport MAX**  
715004204

**\$174.99**

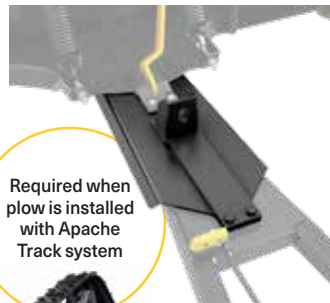

Required when plow is installed with Apache Track system

## CAN-AM PROMOUNT MOUNTING PLATE

- Required to install the Can-Am ProMount Push Frame with Quick-Attach System.
- Mounting plate precision-designed to stay on year round without compromising ground clearance.
- Fits on ATVs, Maverick Trail or Maverick Sport with or without Can-Am Skid Plates.

**Maverick Trail, Maverick Sport, Maverick Sport MAX**  
715004338  
**\$119.99**



# CAN-AM PROMOUNT PLOW ACCESSORIES

### 1 CAN-AM PROMOUNT EDGE MARKERS

- Help locate the edges of your plow.
- Height: 24" (60 cm).
- Sold in pairs.
- Compatible with Can-Am ProMount Steel and Flex2 Blades with or without Blade Extensions (except for the Can-Am ProMount Steel 54" (137 cm) Blades).

**Maverick Trail, Maverick Sport, Maverick Sport MAX**  
715004206  
**\$49.99**



### 2 CAN-AM PROMOUNT PLASTIC WEAR BLADE

- To help prevent scratches on smooth driveways and markable surfaces.

**Maverick Trail, Maverick Sport, Maverick Sport MAX**

54" (137 cm)	60" (152 cm)	66" (168 cm)	72" (183 cm)
715004480	715004481	715004482	715004483 <small>NEW</small>
<b>\$99.99</b>	<b>\$99.99</b>	<b>\$99.99</b>	<b>\$159.99</b>

AVAILABLE IN AUGUST 2019

### 3 CAN-AM PROMOUNT DRIFT CUTTERS

- Help keep snow in the plow.
- Dimensions: 17" x 13" (43.2 cm x 33 cm).
- Sold in pairs.
- Compatible with Can-Am ProMount Steel and Flex2 Blades with or without Blade Extensions (except for the Can-Am ProMount Steel 54" (137 cm) Blades).

**Maverick Trail, Maverick Sport, Maverick Sport MAX**  
715004207  
**\$149.99**

### 4 CAN-AM PROMOUNT BLADE EXTENSIONS

- Add 3" (8 cm) each side.
- Compatible with Can-Am ProMount Blades (except for Can-Am ProMount Steel 54" (137 cm) Blade).
- Longer Wear Blade can be installed to further extend the extra length already provided by the extensions.
- Compatible with Can-Am ProMount Steel and Flex2 Blades (except for the Can-Am ProMount Steel 54" (137 cm) Blades).

**Maverick Trail, Maverick Sport, Maverick Sport MAX**

715004205 • Black  
715005319 • Yellow  
**\$124.99**

### NEW PLOW ANGLING SYSTEM

- Converts your plow system into an easy-to-control unit from the driver's seat.
- Allows you to have full up/down and left/right plow control at your fingertips by using the supplied joystick.
- Using one hand to control all plow motions will allow you to easily concentrate and manage your plowing tasks.

**Compatible with any ProMount Push Frame and Blade**

715006022  
**\$1,169.99**



### PLOW ROLLER FAIRLEAD

- Larger diameter lower roller reduces wear on wire rope for plow application.
- Can be used with all ProMount plows.

**Maverick Trail, Maverick Sport, Maverick Sport MAX**  
705009222  
**\$74.99**



### PLOW LIMIT SWITCH

- (Not illustrated)
- For controlling the cable tension when over raising your plow system.
- Prevents winch, plow push frame and vehicle damage.

**Maverick Trail, Maverick Sport, Maverick Sport MAX**  
715004775  
**\$134.99**

# TRAILERING

## TRAILERING COVER

- Weather-resistant trailering cover protects your vehicle during storage and transportation.
- Heavy-duty canvas made of UV-resistant solution-dyed polyester.
- Inner soft liner protects windshield and colored panels from abrasion.
- All high-abrasion areas are reinforced with a double canvas layer.
- Opening for fuel cap.
- Quick and easy installation.
- Designed to perfectly fit your vehicle with or without Can-Am accessories.

**Maverick Trail, Maverick Sport**

715003706  
**\$399.99**

**Maverick Sport MAX**

715005281  
**\$559.99**



## BOLT-ON<sup>+</sup> RETRACTABLE RATCHETING TIE-DOWNS

- Perfect for transporting your powersport vehicle or securing loads.
- Mounts easily: Bolts on any flat surface (e.g. truck bed or frame).
- 1" x 6' (2.5 cm x 1.8 m) tie-down strap with heavy-duty stitching that delivers a 500 lb (226 kg) working load strength and 1,500 lb (680 kg) break strength.
- Convenient retractable push button automatically slackens, spools and stores away strap, while the ratchet mechanism tightens the strap snugly to secure your vehicle or load into place.
- Rubber ratcheting handle provides firm grip, and the hook is vinyl coated to protect whatever surface it hooks into.
- Sold in pairs.

295100737  
**\$35.99**



## RATCHET TIE-DOWNS

- 400 lb (181 kg) safe working load.
- 1" x 10' (2.5 cm x 3 m) strap with Sea-Doo, Ski-Doo and Can-Am logos.
- Deluxe ratchet with rubber handle.
- Coated S hooks.
- Pack of 2.

860200447 • Black/Grey  
**\$22.99**



# TIRES & RIMS

## MAXXIS LIBERTY TIRE

- Engineered for performance driving and to give you and your side-by-side freedom in a variety of terrains.
- Exceeds DOT test standards.
- 8-ply radial construction.
- Specialized rubber compound for supreme traction and control.
- Excellent tread wear.
- 28" x 10" x 14".

**Maverick Sport X rc**  
705402401  
**\$244.99**



## MAXXIS BIGHORN 2.0 TIRE

**Maverick Sport, Maverick Sport MAX**

Front • 27" x 9" x 12"

705401385

**\$219.99**

705401386 •

Rear • 27" x 11" x 12"

705501817

**\$229.99**

705501818 •



## CARLISLE ACT TIRE

**Maverick Trail**

Front • 26" x 8" x 12"

705402313

**\$179.99**

Rear • 26" x 9" x 12"

705402314

**\$179.99**



## 12" MAVERICK SPORT RIM

- Matching Nuts: 250100184 (Black).
- Matching Cap: 705400928.

**Maverick Sport**

Front • 12" x 6"

Offset = 41mm

705401417

**\$174.99**

Rear • 12" x 7.5"

Offset = 51mm

705501853

**\$184.99**



## 12" MAVERICK TRAIL DPS RIM

- Matching Nuts: 250100184 (Black).
- Matching Cap: 705400928.
- 12" x 6" - Offset = 41 mm

**Maverick Trail**

705401417

**\$174.99**



## 12" MAVERICK TRAIL RIM

- Matching Nuts - 250100042.
- 12" x 6" - Offset = 41 mm

**Maverick Trail**

705401217

**\$99.99**





# RIDING GEAR



**CAN-AM OFF-ROAD RIDING GEAR LIMITED WARRANTY\***

**1-YEAR LIMITED WARRANTY ON SPORTSWEAR AND RIDING GEAR\*\***

**4-YEAR LIMITED WARRANTY ON HELMETS\*\***

\*Purchased at an authorized BRP dealership / distributor or on a BRP-authorized online store. Other exclusions may apply, see complete limited warranty or contact your Can-Am off-road authorized dealer.  
\*\*Unless otherwise stipulated or required by law.





**New ZIPPED HOODIE**

60% Cotton,  
40% Polyester Fleece  
286709 • S-3XL  
Heather Grey (27),  
Black (90)  
\$94.99

**New CAN-AM PULL-OVER HOODIE**

60% Cotton,  
40% Polyester Fleece  
286708 • S-3XL  
Khaki (05), Black (90)  
\$89.99

**CAN-AM SHIRT**

60% Cotton,  
40% Polyester  
454074 • S-3XL  
Khaki (05), Black (90)  
\$74.99

**New LONG SLEEVE ORIGINAL TEE**

100% Cotton  
286717 • S-3XL  
White (01), Green (70)  
\$39.99

**New ORIGINAL TEE**

100% Cotton  
286712 • XS-3XL  
Heather Grey (27),  
Black (90)  
\$29.99

**New X-RACE TEE**

100% Cotton  
286714 • XS-3XL  
White (01),  
Black (90)  
\$29.99

**New INTRUSION TEE**

100% Cotton  
286716 • XS-3XL  
Heather Grey (27),  
Green (70), Black (90)  
\$29.99

**New LADIES' ORIGINAL TEE**

95% Cotton, 5% Spandex  
286715 • XS-2XL  
White (01), Black (90)  
\$29.99

**New LADIES' X RACE TEE**

95% Cotton,  
5% Spandex  
286713 • XS-2XL  
Green (70), Black (90)  
\$29.99

**ADVENTURE TEAM JERSEY**

- Quick-dry, antibacterial, moisture-wicking fabric.
- Extended back for coverage while riding.
- Mesh fabric for extra ventilation underarms.
- Non-fading sublimated graphics.

100% Polyester  
454072 • S-3XL  
Sunburst Yellow (96),  
Red (30)  
\$59.99

**New X-RACE JERSEY**

- Ultralight, quick-dry, antibacterial and moisture-wicking fabric.
- Mesh fabric for maximum breathability.
- Extended back for coverage while riding.
- Non-fading sublimated graphics.

100% Polyester.  
286710 • S-3XL  
Orange (12), Green (70)  
\$59.99

**New LADIES' TEAM JERSEY**

- Semi-fitted cut specifically designed for ladies.
- Quick-dry, antibacterial, moisture-wicking fabric for maximum comfort.
- Mesh fabric for extra ventilation underarms.
- Non-fading sublimated graphics.

90% Polyester, 10% Spandex  
286711 • XS-2XL  
Orange (12), Green (70)  
\$59.99

**MUD GEAR****MUD JACKET**

- 100% waterproof PVC.
- Electronically-welded seams.
- Underarm and rear vent panels.
- 2 hand pockets.
- Elastic cuffs.
- Drawstring hood and hem.

Polyvinyl Chloride (PVC)  
286676 • S-2XL  
Clear (00), Matte Black (93)  
\$39.99

**MUD PANTS**

- Oversized pants made of 100% waterproof PVC.
- Electronically-welded seams.
- Strategically placed ventilation.
- Side openings at bottom leg.

Polyvinyl Chloride (PVC)  
286128 • S-2XL  
Clear (00), Matte Black (93)  
\$19.99

**New ORIGINAL CAP**

- Plastic adjustment strap at back.

100% Cotton  
286707 • One size • Khaki (05), Black (90)  
\$29.99

**New CLASSIC CAP**

- Plastic adjustment strap at back.

100% Cotton  
447702 • One size • Charcoal Grey (09), Black (90)  
\$29.99

**New X RACE CAP**

- Mesh at back.
- Plastic adjustment strap at back.

55% Cotton, 45% Polyester  
286705 • One size • Orange (12), Green (70), Black (90)  
\$29.99

**New INTRUSION FLAT CAP**

- Mesh at back.
- Plastic adjustment strap at back.

100% Cotton  
286706 • One size • Black (90)  
\$29.99







## ENDURO

Designed for long rides and high adventure.

### FEATURES & BENEFITS

- Offers the dual experience of riding with a visor helmet plus the look and advantages of an MX helmet.
- Advanced plastic composite shell.
- Lockable, multi-positions and anti-scratch visor.
- Interchangeable retractable sun visor.
- Removable aerodynamic peak.
- Ultra-comfort and washable Dri-Lex<sup>1</sup> linings.
- Oversized and vented chin deflector.
- Adjustable air vents and exhausts.

### EX-2 ENDURO HELMET

Shell: Polycarbonate Composite  
448466 • XS-2XL • Black with graphics (94)

\$249.99

DOT ECE22.05



## XP-3

Superlight cross-style helmet: Feature-packed for exceptional performance, protection and comfort.

### FEATURES & BENEFITS

- 4-year limited warranty.
- Weight: ±1380 grams for size Large.
- Premium shell construction using superlight fiberglass and impact absorbing EPS liner.
- Aero-tuned fully adjustable visor system.
- Custom stainless grill design.
- Front and rear hi-max air vent system to maximize cooling.
- Removable, washable and replaceable CoolMax<sup>™</sup> moisture-wicking liner.
- Lightweight double-D chin strap.
- Triple certified: DOT, ECE and SNELL M2015.

### New XP-3 PRO CROSS X-RACE HELMET

Shell: Fiberglass  
448612 • XS-2XL  
Charcoal Grey (07), Green (70)

\$289.99

DOT Snell ECE22.05



## XC-4

Motocross style that combines lightweight construction, comfort and features beyond its price range. Value you can't ignore.

### FEATURES & BENEFITS

- 4-year limited warranty
- Weight: ±1420 g for size Large.
- Front and rear hi-max air vent system to maximize cooling effect.
- Shell construction is superlight polycarbonate with impact absorbing liner.
- Fully adjustable visor system.
- Removable, washable and replaceable moisture-wicking liner.
- Winter breath deflector (sold separately).
- Lightweight double-D chin strap.

### New XC-4 CROSS TEAM HELMET

- Durable multi-colored clear coated graphics.
- Can-Am branded.

Shell: Polycarbonate Composite

448608 • XS-2XL  
Charcoal Grey (07), Red (30)

\$179.99

DOT ECE22.05



## DUST MASKS

- Easily replaceable filters remove 99.9% of airborne dust, particles, pollen and odors.
- Made from soft yet durable neoprene material that fits snugly under helmets and goggles.
- XS/S fits most kids 12 and under, M/L fits most riders and XL/2XL fits larger frames (235+ lbs).
- Includes 2 replacement filters and a small storing pouch.
- Replacement filter (447719) available.

### CAN-AM ORIGIN DUST MASK

448524 • XS/S, M/L, XL/2XL • Black with graphics (94)  
\$41.99



### CAN-AM VENTED DUST MASK

448525 • XS/S, M/L, XL/2XL • Black (90)  
\$47.99



## COMMUNICATION SYSTEM

### SENA 30K BLUETOOTH COMM SYSTEM

- Bluetooth headset that operates on Sena's Mesh Intercom<sup>™</sup> technology.
- The 30K has a new quick charge feature meaning just 20 minutes of charging gets riders an impressive 5 hours of Bluetooth intercom use, or 3 hours Mesh Intercom use.
- 2.4 GHz frequency, connecting to other riders in an entirely new way.
- Should one of the group's riders go out of range, the Mesh Intercom intelligently keeps the rest of the group in seamless communication, while actively searching to reconnect, should that rider come back within range.
- Using the private group mode, the 30K can pair in full duplex communication with up to 16 riders at a range up to 1.2 miles (2 km).
- Sena 30K Audio Multitasking technology allows you to have a conversation via Adaptive Mesh-Networking technology while simultaneously enjoying Bluetooth operations such as streaming smartphone music, taking or making phone calls, or listening to turn-by-turn GPS navigation.

SINGLE PACK  
448610 • One size • Black (90)  
\$399.99

DUAL PACK  
448611 • One size • Black (90)  
\$699.99



\*Some models and accessories shown may not be available or homologated in your country. Contact your BRP dealer or local authorities for information.





## GOGGLES

### CAN-AM RACE SAND GOGGLES BY SCOTT

- Dust catcher vent foam.
- Custom painted frame and strap graphics.
- UV protected Lexan® lens with No Fog™ anti-fog lens treatment.
- Hypoallergenic multi-layer face foam.
- Durable and anti-slip full strap attachment.
- Extra clear lens in the box.
- Storing pouch included.
- Speed Strap attachment system compatible (sold separately).
- Tear-off and roll-off compatible (sold separately).

448638 • One size • Black (90)

\$99.99



### CAN-AM TRAIL GOGGLES BY SCOTT

- UV protected Lexan® lens.
- Hypoallergenic super-soft face foam.
- Speed Strap attachment system compatible (sold separately).
- Durable and anti-slip full strap attachment.
- Tear-off and roll-off compatible (sold separately).

448616 • One size • White (01), Red (30), Black (90)

\$44.99



## GLOVES

### New X-RACE GLOVES

- Air mesh panels for ventilation and mobility.
- Double Clarino® layer at palm and thumb for extra durability and comfort.
- Pre-curved design.
- Silicone fingertip for better grip.
- Hook-and-loop wrist closure system.

Shell: Air Mesh, Spandex, Clarino®



MEN'S

286718 • XS-2XL • Orange (12), Green (70)

\$49.99



LADIES'

286719 • S-2XL • Orange (12), Pink (36)

\$49.99

### ADVENTURE TEAM GLOVES

- Spandex construction for flexibility.
- Chamude palm.
- Pre-curved design.
- Slip-on gloves.
- Silicon print at inner fingers.

Shell: Spandex, Chamude, Polyester

446305 • S-3XL • Red (30)

\$34.99



## JUNIOR

### JUNIOR X CRUSH HELMET

- Multi-density EPS liner.
- Ultra-plush removable/washable liners.
- Adjustable visor to protect from the elements.
- Multiple air vents help keep you cool and dry.
- Lightweight double-D chin strap.
- Ski-Doo and Can-Am stickers in the box.
- Optional breath deflector (sold separately).

Shell: ABS

448506 • S, M, L • Black with graphics (94)

\$129.99



### New CAN-AM BUZZ GOGGLES BY SCOTT

- UV protected Lexan® lens.
- Hypoallergenic super-soft face foam.
- Durable and anti-slip full strap attachment.
- Speed Strap attachment system compatible (sold separately).

448620 • One size • Black (90)

\$44.99



## BAGS

### CAN-AM CARRIER DRY BACKPACK BY OGIO

- Completely waterproof rolltop construction.
- Reflective screen print.
- Airflow back panel keeps the rider cool.
- 2-way adjustable sternum strap.
- Dual-density shoulder straps for maximum comfort.
- Removable inner liner to allow bigger storage.
- Laptop and tablet sleeves.
- Organization panel with 2 zippered pockets.
- Dimensions: 20.5" H x 10.5" W x 6.75" D (52 cm x 27 cm x 17 cm).

100% Polyester

469544 • One size • Black (90)

\$159.99



### CAN-AM SLAYER GEAR BAG BY OGIO

- Large main compartment with easy access to all gear.
- Large separated boot pocket.
- Zippered accessory pocket.
- Easy grab handles for transport.
- Detachable shoulder strap.
- Heavy-duty reinforced base.
- Dimensions: 32" H x 16" W x 18" D (81 cm x 41 cm x 46 cm).

100% Polyester

469294 • One size • Black (90)

\$129.99



### CAN-AM URBAN BACKPACK BY OGIO

- Airport security friendly protective laptop compartment.
- Padded iPad™/tablet/e-reader pocket.
- Dual side water bottle/accessory holders.
- Fully adjustable ergonomic shoulder straps.
- Front pocket with 2 padded accessory compartments and slip pocket.
- Dimensions: 19.5" H x 13.5" W x 9.5" D (50 cm x 34 cm x 24 cm).

100% Polyester

469293 • One size

Black (90)

\$109.99



# HOW TO MEASURE

- For best results, have someone else take measurements.
- Measure body in underwear.
- Tape must be snug but not tight.
- If measurements fall between two sizes, order the larger size.

- HEAD** Around your head, from the center of the forehead, above the ears and over the natural bump at the back of the head.
- ARM LENGTH** Let the hands hang down on the side in a slightly bent position. Measure from the center of the back of your neck, along the length of your arm, to the wrist.
- CHEST/ BUST** Measure under your arms, around the fullest part of your chest.
- WAIST** Measure around your natural waistline, keeping one finger between the tape and body.
- HIPS** Across the fullest part of the seat.
- INSEAM** Without shoes, from crotch to the floor.

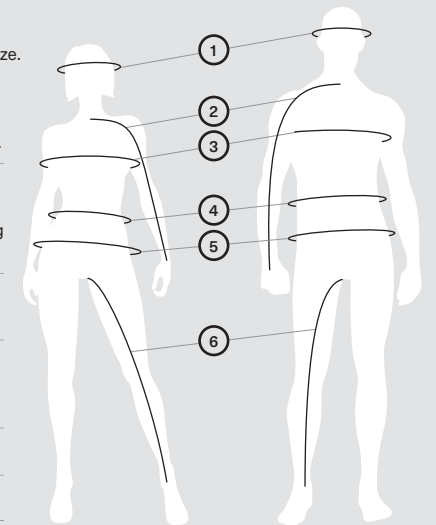

## WHAT CODE REPRESENTS YOUR SIZE?

1. Find your size.
2. The corresponding code is **THE CODE** you use to complete the part number on your order. Example: 440227\_\_90 Size: M = Code "06", therefore 4402270690

SIZE	CODE	SIZE	CODE	SIZE	CODE	SIZE	CODE	SIZE	CODE
One Size	00	XL	12	4XLT	19	6	25	13	33
XS	02	XLT	13	5XL	88	7	27	14	34
S	04	2XL	14	1	20	8	28	16	35
M	06	2XLT	15	2	21	9	29	18	78
MT	07	3XL	16	3	22	10	30	3-4	79
L	09	3XLT	17	4	23	11	31	5-6	52
LT	10	4XL	18	5	24	12	32	6-8	48
								7-8	54
								10-12	49
								14-16	50
								S/M	72
								M/L	91
								L/XL	73

## RIDING GEAR & SPORTSWEAR

### MEN'S-1.74 M - 1.83 M

	XS	S	M	L	XL	2XL	3XL
Chest	86-91	91-97	97-104	104-114	114-124	124-135	135-145
Waist	71-76	76-81	81-89	89-99	99-109	109-122	122-132
Hips (seat)	86-91	91-97	97-104	104-114	114-124	124-135	135-145
Arm length	76-79	79-81	81-84	84-86	86-89	89	89-91
Inseam	79-80	80-81	81	81	81	81	81

### LADIES'-1.60 M - 1.77 M

	XS	S	M	L	XL	2XL	3XL
Chest	81-86	86-91	91-99	99-107	107-117	117-127	127-137
Waist	66-71	71-76	76-84	84-91	91-102	102-112	112-122
Hips (seat)	89-94	94-99	99-107	107-114	114-124	124-135	135-145
Arm length	76	76	77	79	80	81	84
Inseam	76	76	76	76	76	76	76

## GLOVES (measure palm width)

### MEN'S

	S	M	L	XL	2XL	3XL
Palm (cm)	8	9	10	11,5	13	14

### LADIES'

	S	M	L	XL	2XL
Palm (cm)	7	8	9	10	11.5

## HELMETS

### MEN'S & LADIES'

	XS	S	M	L	XL	2XL	3XL
Head (cm)	53-54	55-56	57-58	59-60	61-62	63-64	65-66

### JUNIOR

	S	M	L
Head (cm)	49-50	51-52	53-54





1



2



7



8



9



3

TAKE YOUR CAN-AM PRIDE FARTHER THAN EVER BEFORE

# ALL-NEW CAN-AM LIFESTYLE COLLECTION

MORE THAN 65 PRODUCTS FOR HOME, GARAGE, OFFICE, TRAVEL, AND MOBILE DEVICES!

Explore them all online at [CAN-AMOFFROAD.COM](http://CAN-AMOFFROAD.COM) or check out the selection instock at your favorite **Can-Am dealer!**



10



4



6



11



12



5



13



14

1. Versatile Backpack - \$109.99 2. Parking Only Sign (8" x 12") - \$24.99 3. Neon Clock - \$96.99 4. Faux Fur Throw - \$112.99 5. Metal Bar Stools - \$136.99 (Available in July) 6. Sport Bag - \$62.49 7. 40- Can Cooler Backpack - \$169.99 8. Fleece Throw - \$64.99 9. iPhone 7/8 Case - \$31.99 10. Aprons - \$16.99 (Available in July) 11. Luxury Notebook - \$66.99 12. Dog Leash and Collar - \$31.99 13. License Plate Frame - \$16.99 14. Welcome Mat (21" x 59") - \$89.99



# KEEP YOUR CAN-AM PERFORMING AT ITS BEST

Remember what made you fall for a Can-Am vehicle? Precisely engineered. Rigorously tested. Factory approved. The ultimate off-road experience continues with Genuine Can-Am Parts, whether installed by our trusted network of trained dealers—or Do-It-Yourself installed in the comfort of your garage.



## DIY WITH PRIDE

You love to wrench on your Maverick Trail / Maverick Sport— so we've got you covered with a listing of the most popular replacement parts (p.81).



\*For new genuine parts sold through BRP. Includes items installed by you or authorized BRP dealer. Other exclusions may apply, see complete limited warranty or contact your Can-Am off-road authorized dealer.

### ENGINE OIL CHANGE KIT

All-in-one solution that saves time and money. (p.87).



Visit the [can-amoffroad.com](http://can-amoffroad.com) Parts & Maintenance section to see the full line of Genuine Can-Am Parts.



## REGULAR MAINTENANCE ENSURES YOUR MAVERICK SPORT OR MAVERICK TRAIL PERFORMS AS YOU EXPECT

KEEP AN EYE ON THESE COMPONENTS\*

- ✓ OIL FILTER 420256188
- ✓ ENGINE OIL SEE P.86
- ✓ FUEL FILTER 709000330
- ✓ AIR FILTER 715900394/715900422
- ✓ CVT AIR FILTER 706600281
- ✓ DRIVE BELT 422280654
- ✓ BRAKE PADS SEE P.82
- ✓ BOOT KITS SEE P.82
- ✓ WHEEL BEARINGS 293350118
- ✓ A-ARM BUSHINGS 703500875
- ✓ BALL JOINTS 706203084/706202045
- ✓ SPARK PLUG 707000246
- ✓ BATTERY 410301203

\*Refer to periodic maintenance chart for proper intervals.



## GENUINE CAN-AM MAINTENANCE PARTS

**OIL FILTER**  
420256188



**PERFORMANCE AIR FILTER BY TWIN AIR**  
• The best choice for the harshest conditions.  
• Multiple staged oiled filtering foam for superior dust retaining capacity with high air flow.  
• Washable and reusable.  
715002895



**O-RING (DRAIN PLUG)**  
(Not illustrated)  
420552280

**O-RING (OIL FILTER COVER)**  
(Not illustrated)  
420230920

**PREMIUM AIR FILTER**  
• The best filter on the market, they prevent airborne contaminants from reaching your engine.  
• Protects internal components against premature wear.  
• Genuine BRP air filters ensure absolute compatibility and a perfect fit.  
715900394 • Engines 800 & 1000  
715900422 • Engine 1000R



**CVT AIR FILTER**  
(Not illustrated)  
706600281

**SPARK PLUG**  
707000246



**FUEL PRE FILTER**  
(Not illustrated)  
270600113

**FUEL FILTER**  
(Not illustrated)  
709000330  
EVAP Models Only  
709000100

**FUEL AIR BREATHER FILTER**  
(Not illustrated)  
709000524

Note: Please contact your dealer or visit our online store at [can-amoffroad.com](http://can-amoffroad.com) for suggested retail prices regarding Genuine Can-Am Parts.



**PREMIUM DRIVE BELT**

- High-performance design ideal for off-road use.
- BRP-specific calibration adjusted to best suit your Can-Am vehicle.

422280654



**CVT GASKET COVER**

(Not illustrated)  
420450400

**DRIVEN PULLEY EXTRACTOR**

(Not illustrated)  
Maverick Trail, Maverick Sport  
529036352

**DRIVEN PULLEY ADAPTOR**

(Not illustrated)  
Maverick Trail, Maverick Sport  
708200686

**CV BOOT KITS**

- Come with clamps and grease.
- Genuine BRP CV Boot Kits ensure absolute compatibility and a perfect fit.

<b>Front Wheel Side</b>	<b>Front Differential Side</b>
705401354 • Maverick Sport (ABS, Xxc, Xmr, Xrc Models Only)	705401355 • All Maverick Trail, All Maverick Sport
705401345 • Maverick Sport (NO ABS), Maverick Trail	<b>Rear</b> 705501864 • All Maverick Trail, All Maverick Sport



**A-ARM BUSHING KIT**

- This bushing kit includes 2 bushings, a sleeve and a wearplate, as illustrated. All you need to renew your suspension A-Arms.

703500875



**METALLIC BRAKE PAD KIT**

- Built strong to last long – heavy-duty construction stands up to hard braking.
- Designed to handle demanding riding conditions with challenging braking environments such as mud and dunes.
- Created specifically for use with Can-Am vehicles.

715900379 • Front Left      715900380 • Front Right  
715900386 • Rear Left      715900387 • Rear Right

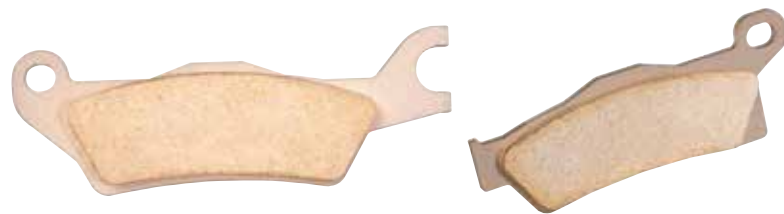

**YUASA<sup>†</sup> BATTERIES**

- Top of the line models from the leading preferred original equipment battery supplier in North America.

410301203 • 18 Amps. Wet • (YTX20L-BS)

**30 AH BATTERY UPGRADE**

- Requires 30ah Battery Holder (715004431).
- Please refer to your user manual for removal and installation.

515176151



**PREMIUM HALF SHAFT**

- Premium quality design ideal for off-road, heavy-duty and low speed torque usage.
- Includes CVs, Shaft and Boots with the best suited geometry for your Can-Am vehicle.

Models	Front Left	Front Right	Rear
Maverick SPORT (ABS Models)	705402443	705402443	705502756
Maverick SPORT BASE, DPS	705402031	705402030	705502552
Maverick TRAIL (W/O ABS)	705402008	705402007	705502541
Maverick TRAIL (ABS Models)	705402442	705402442	705502755



**PERFORMANCE HALF SHAFT**

- High-performance design ideal for off-road use with superior wheel power and acceleration for racing, dunes, trails and desert riding.
- Includes CVs, Shaft and Boots with the best suited geometry for your Can-Am vehicle.

Models	Front Left	Front Right	Rear
Maverick Sport Xmr / Maverick Sport Xrc	705402282	705402282	705502757

**WHEEL BEARINGS**

- (Not illustrated)
- Sealed bearings for additional protection from water and dirt.

293350118 • Front & Rear

**BALL JOINTS**

- Robust design for off-road usage and sealed for prolonged durability.

706203084 • Upper  
706202045 • Lower



Note: Please contact your dealer or visit our online store at can-amoffroad.com for suggested retail prices regarding Genuine Can-Am Parts.

# WHAT MAKES CAN-AM BELTS STAND OUT?



"I'VE TESTED EVERY BELT OUT THERE, AND CAN-AM'S DRIVE BELTS ARE WHAT I RELY ON TO WIN RACES."

**PHIL BLURTON**

2017-2018-2019 UTV World Championship Winner  
2017-2018 BITD UTV Pro Production Turbo Champion



**Consistent quality**

We partner with the best manufacturers in the powersports industry to offer you unique drive belts with consistent quality.

**Prolonged durability**

The 100% cutting-edge PBO high-tensile strength polymer fiber construction offers high-temperature robustness and prolonged durability.

**Tested performance**

Our engineering teams have perfectly integrated and tested each drive belt to provide quick throttle response, powerful acceleration, top speed and consistent shifting performance.

**Custom calibration**

We aim at delivering the highest levels of performance and longevity based on your vehicle's specific end-use and calibration.

## CAN-AM BELT CONSTRUCTION VS. COMPETITORS

### MODULUS & TENSILE STRENGTH

Based on Dynamometer testing, PBO surpasses Kevlar and Carbon Fiber materials in every way.

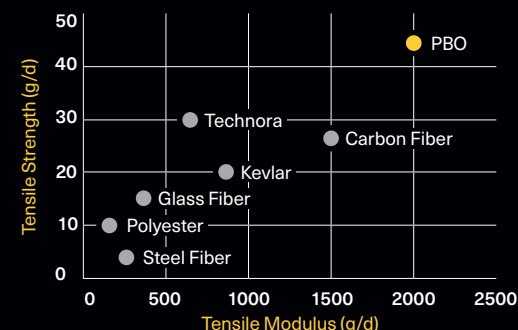

### DURABILITY COMPARISON

Compared to Can-Am's Performance Drive Belt.

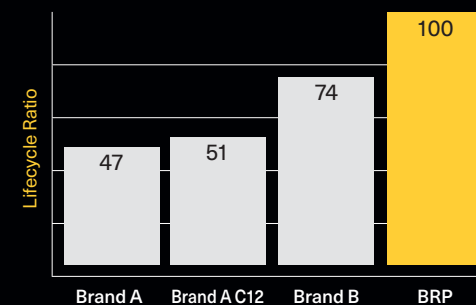





**Hunter Miller**  
 2018 GNCC XC1 PRO TURBO UTV CHAMPION  
 Multiple-time short course champion  
 Hunter Miller has won with XPS in all conditions.



**Kyle Chaney**  
 2017 TORC PRO MOD UTV CHAMPION  
 AND MULTI-TIME GNCC CHAMPION  
 Experienced short course and cross country  
 champion racer Kyle Chaney relies on XPS  
 to hold up to extreme race conditions.



**Phil Blurton**  
 2017-2018-2019 UTV WORLD CHAMPIONSHIP WINNER  
 2017-2018 BITD UTV PRO PRODUCTION TURBO CHAMPION  
 XPS lubricants are what get a naturally-gifted driver  
 like Phil Blurton to the top of the podium.

XPS oil undergoes rigorous worst-case scenario testing, and as a result is the trusted lubricant of many Can-Am racers.



# WHY XPS OIL IS THE PERFECT FIT FOR YOUR ROTAX ENGINE?

Just like you count on Can-Am to help you make the most of every terrain, you can trust XPS to ensure the long-lasting performance and durability of your Rotax engine.

## ULTIMATE PERFORMANCE

Engineered to match the advanced performance of Rotax engines.

## UNMATCHED RELIABILITY

Get the most out of every mile on every ride.

## MADE FOR THIS

Developed with Rotax engines to deliver the best performance and lubrication in all conditions.



<https://www.brp.ca/off-road/xps.html>





# ALL SET FOR YOUR RIDE?

## GET THE OIL CHANGE KIT THAT KEEPS YOUR ROTAX ROARING

Protecting your investment by changing your engine oil at regular intervals should be at the top of your maintenance to-do list. To make the task easier, we developed the XPS Engine Oil Change Kit for an all-in-one solution that saves time and money.

<https://www.brp.ca/off-road/xps.html>



### ENGINE OIL CHANGE KIT

- Ultra-convenient "all-in-one" Engine Oil Change Kit saves time and money.
- Includes XPS Synthetic or Synthetic Blend Oil, oil filter, o-rings and washer.

**779256 • Synthetic Blend**  
(5W-40 450 cc or less (except Rally and DS ATVs))

**779257 • Full Synthetic**  
(0W-40 450 cc or less (except Rally and DS ATVs))

**779258 • Synthetic Blend (5W-40 500 cc or more V-twin engine)**

**779259 • Full Synthetic (0W-40 500 cc or more V-twin engine)**

**779252 • Full Synthetic (10W-50 500 cc or more V-twin engine)**

**779260 • Synthetic Blend (5W-40 900 ACE)**

**779261 • Full Synthetic (10W-50 900 ACE)**



EXPERT CHOICE

Love to DIY? Save money, time, and effort: everything you need for an oil change is in this box.

### 4T 10W-50 SYNTHETIC OIL

- Engineered for heavy-duty and high-performance 4-stroke engines, including turbocharged, supercharged and racing engines.
- Formulated using carefully selected and strenuously tested base stocks and custom additives.
- Offers thick film strength to protect bearings, and a proven high-temp detergency to minimize deposits, prevent shear, provide thermal stability, and combat fuel dilution to ensure maximum performance from your engine.

**779234 • 1 quart / 946 ml**

**779235 • 1 US gallon / 3.785 L**

### 4T 0W-40 SYNTHETIC OIL

- 4-stroke engines powering recreational vehicles through mud, snow and water withstand a lot of high RPM and high load abuse, and this full synthetic oil is carefully engineered to provide the best protection for high-performance ATVs and SSVs.
- Its wide operating temperature range, additional corrosion protection, and engineered detergency make this oil the best choice for any powersport vehicle with a 4-stroke engine used in cold weather.

**779139 • 1 quart / 946 ml**

**779140 • 1 US gallon / 3.785 L**

### 4T 5W-40 SYNTHETIC BLEND OIL

- This synthetic blend is the oil of choice for owners of high-performance vehicles with a 4-stroke engine, including turbo or supercharged engines requiring carefully engineered friction.
- Combining the finest quality synthetic base stocks with extreme-tested synthetic additives, it provides superior engine and transmission protection against rust and corrosion compared to conventional engine oils.

**779133 • 1 quart / 946 ml**

**779134 • 1 US gallon / 3.785 L**

### SYNTHETIC GEAR OIL

- Uses custom additives to provide the best performance in Visco-Lok & Smart-Lok differentials.
- Allows higher loads, superior shear stability and reduced oxidation.
- Exceptional wear protection and superior performance at all operating temperatures.

**75W-90**

**779158 • 1 quart / 946 ml**

**75W-140**

**779160 • 1 quart / 946 ml**



### SYNTHETIC GREASE SUSPENSION

- Designed to work specifically with the components found in Can-Am vehicle suspensions.
- It is highly stable and offers optimal lubrication at both extreme cold and high temperatures while protecting suspension components from dirt and moisture, as well as corrosion under extreme washout conditions.

**779163 • 14 oz. / 400 g**



### ANTI-CORROSIVE LUBRICANT

- Multipurpose lubricant that can also be used to prevent rust, corrosion and moisture intrusion.
- It contains extreme pressure additives that work as an all-around lubricant for just about anywhere lubrication is needed.

**779168 • 12 oz. / 340 g**



### EXTENDED LIFE PRE-MIXED COOLANT

- XPS Antifreeze/Coolant contains the correct dilution and the necessary additives to prevent corrosion and inhibit cavitation in BRP cooling systems.
- Long-life, 5-year formula specially formulated for BRP vehicles.
- Superior heat transfer.
- Ideal replacement for vehicles that normally use a 2-year antifreeze/coolant (green).

**779150 • 1 quart / 946 ml**



Note: Please contact your dealer or visit our online store at [can-amoffroad.com](http://can-amoffroad.com) for suggested retail prices of XPS products.

Note: Please contact your dealer or visit our online store at [can-amoffroad.com](http://can-amoffroad.com) for suggested retail prices of XPS products.



**DOT4 BRAKE FLUID**

- Meets or exceeds all DOT3 and DOT4 brake fluid requirements.
- High-temperature formula resists fade, and also conditions seals and o-rings in braking system.

779151 • 12 oz. / 355 ml

**RACING BRAKE FLUID**

- Exceeds DOT4 brake fluid requirements for extreme conditions and competition use.
- Extreme, 579-degree boiling point temperature is ideal for high-demand competition conditions to combat brake fade.
- Will not harm seals or braking system components.
- Should be added only to a clean/unfilled system to avoid dilution and diminished performance.
- Low-moisture formula slows water vapor absorption through multiple heat cycles.
- Recommended for use in Ski-Doo and Can-Am racing applications.

779152 • 12 oz. / 355 ml

**HIGH PERFORMANCE SUSPENSION FLUID**

- A synthetic, fade-free formula for servicing FOX® shocks.
- Specially formulated for high-demand or racing application.
- Ultra high VI shock oil.
- Engineered viscosity for optimized performance with FOX® shocks valving.

779153 • 1 quart / 946 ml

**FUEL STABILIZER**

- Ethanol-compatible and will stabilize fuel in your tank to keep it from breaking down and causing hard starting, throttle hesitation and poor run quality.
- Ethanol attracts moisture, and this product contains powerful anti-corrosion additives to protect fuel system components.
- Prevents problems associated with E10 fuels.

779171 • 8 oz. / 236 ml

**CARBON FREE FUEL TREATMENT**

- Combination of a fuel treatment and a fuel system cleaner that can be used periodically to restore lost starting or throttle performance, as well as maintain fuel system integrity and keep internal engine parts clean.
- It treats fuel for storage and addresses the moisture problems inherent in today's Ethanol-blended fuels, keeping ferrous and soft metal parts clean and free of corrosion.
- Uses patented, state-of-the-art additives.
- Cleans valves, sticky rings and combustion chamber.

779169 • 12 oz. / 355 ml

**FUEL TREATMENT CARBURETOR CLEANER**

- Complete fuel treatment specially formulated to prevent small engine problems caused by Ethanol-blended fuels.
- It removes fuel system gum and varnish that may have accumulated during storage, stabilizes fuel against breakdown for 12 months or more, and adds corrosion protection from moisture for short- and long-term storage.
- It also helps restore throttle response and easy starting.
- It can be used periodically to maintain fuel system integrity, keep carburetor jets clean, and also combat moisture problems caused by Ethanol-blended fuels to keep ferrous and soft metal parts clean and free of corrosion.

779172 • 12 oz. / 355 ml

**SPRAY CLEANER & POLISH**

- Removes dirt, grease, road grime and water marks easily and quickly.
- Non petroleum based formula will not harm plastic finishes.
- Protects against UV and ozone damage and resists dirt accumulation.
- It can be used on painted surfaces, fiberglass, chrome and plastics.

219702844 • 12 oz. / 340 g

**OFF-ROAD VEHICLE WASH**

- A biodegradable non-toxic cleaner that removes mud and dried-on dirt from your off-road vehicle.
- Whether grimy from the track, the woods or the fields, this cleaner will leave your off-road vehicle sparkling.
- When used as directed, XPS Wash is safe for all off-road vehicle finishes.

219701702 • 32 oz. / 946 ml

**MICROFIBER TOWELS**

- The latest in high-quality detailing towels.
- Made up of extremely fine fibers, their soft surfaces have been perfected for drying and polishing painted, gel coated and hard shiny surfaces.
- They are so absorbent they hold up to seven times their weight in water.
- Machine washable means they can be used over and over again.
- Pack of 2.

219701759

EXPLORE AN ENTIRE WORLD OF ADVENTURE WITH ALL OF OUR BRP PRODUCTS. [BRP.COM](http://BRP.COM)

ski-doo LYNX SEA-DOO EVINRUDE ROTAX can-am

Note: Please contact your dealer or visit our online store at [can-amoffroad.com](http://can-amoffroad.com) for suggested retail prices of XPS products.